

**REPORT OF THE
DEPARTMENT OF RAIL AND PUBLIC TRANSPORTATION**

Rails with Trails/Pedestrian Crossing Project Initiation, Coordination and Review

**TO THE GOVERNOR AND
THE GENERAL ASSEMBLY OF VIRGINIA**



REPORT DOCUMENT NO. 404

**COMMONWEALTH OF VIRGINIA
RICHMOND
2009**



COMMONWEALTH of VIRGINIA

CHARLES M. BADGER, P.E.
Director

DEPARTMENT OF RAIL AND PUBLIC TRANSPORTATION
600 EAST MAIN STREET, SUITE 2102
RICHMOND, VA 23219-2416

(804) 786-4440
FAX (804) 225-3752
VIRGINIA RELAY CENTER
1-800-828-1120 (TDD)

The Honorable Timothy M. Kaine
Governor of Virginia
Patrick Henry Building, 3rd Floor
1111 East Broad Street
Richmond, Virginia 23219

Senator Yvonne B. Miller
Chairman, Senate Transportation Committee
General Assembly Building, Room 315
Richmond, Virginia 23219

Delegate Joe T. May
Chairman, House Transportation Committee
General Assembly Building
P.O. Box 406
Richmond, Virginia 23218

Ladies and Gentlemen:

Attached for your review is the "Rails with Trails/Pedestrian Crossing Project Initiation, Coordination and Review" that was requested by the 2009 General Assembly session in HB 2088. This report is provided by the Virginia Department of Rail and Public Transportation on behalf of the Secretary of Transportation, and responds to the General Assembly's direction to:

- i. Develop a process to coordinate and evaluate public recreational access and safety issues directly related to new railroad projects, if appropriate, that are funded in whole or in part by the Commonwealth.
- ii. Submit a report to the Chairmen of the House and Senate Transportation Committees communicating the results.

Sincerely,

A handwritten signature in cursive script, appearing to read "Charles M. Badger".

Charles M. Badger
Director

cc: Pierce R. Homer, Secretary of Transportation

The Smartest Distance Between Two Points
www.drpt.virginia.gov

Table of Contents

Executive Summary	ii
1. Introduction.....	1
1.1 Purpose and Need	1
1.2 Stakeholder Interests	2
1.2.1 Railroads	2
1.2.2 Recreational Access and Public Crossing Advocates.....	2
1.3 Limitations of the Report	2
1.4 Recreational Access and Railroad Interface Process	3
2. Project Interface and Development.....	4
2.1 Course of Action for Rails with Trails/Pedestrian Crossing Development	4
2.1.1 Project Feasibility	4
2.1.2 Stakeholder Identification and Outreach	6
2.1.3 Master Planning	6
2.1.4 Implementation Plans.....	7
2.2 Rails with Trails/Pedestrian Crossing Project Initiation, Coordination and Review ..	7
2.2.1 Rails with Trails/Pedestrian Crossing Proposal Submission for Existing Rail Lines.....	7
2.2.2 Process for Considering Rails with Trails/Pedestrian Crossings for new Rail Projects Funded with Rail Enhancement Funds	9
2.3 Legal Issues.....	10
2.4 Additional Resources	11

Appendices

Appendix A: Design Considerations for the Establishment of Rails with Trails/Pedestrian Crossings in the Commonwealth of Virginia Technical Memorandum	12
---	----

List of Figures

Figure 2-1: Steps in an RWT/PC Feasibility Study	5
--	---

Executive Summary

Purpose and Need

The 2009 Session of the General Assembly, through HB 2088 stated the following:

“No later than December 1, 2009, the Department of Rail and Public Transportation, the Department of Game and Inland Fisheries, and the Department of Conservation and Recreation shall develop a process to coordinate and evaluate public recreational access and safety issues directly related to new railroad projects, if appropriate, that are funded in whole or in part by the Commonwealth, and shall send a report to the Chairmen of the House and Senate Transportation Committees communicating the results.”

The Virginia Department of Rail and Public Transportation (DRPT), the Virginia Department of Conservation and Recreation (DCR) and the Virginia Department of Game and Inland Fisheries (DGIF) developed these recommended processes and procedures. In order to accomplish this, staff from the respective departments held stakeholder meetings with representatives from CSX Transportation (CSX), Norfolk Southern (NS), the Virginia Railroad Association (VRA), Bike Walk Virginia, Virginia Bike Federation, Float Fishermen of Virginia, Friends of the Rivers of Virginia, Richmond Area Bicycling Association, local governments and other recreational user groups to gain input on the proposed process to address recreational and safety issues and consider public recreation access to new railroad projects. In addition, the departments consulted the Virginia Department of Transportation (VDOT) and the United States Department of Homeland Security, Transportation Safety Administration (TSA) for technical guidance on infrastructure design and safety parameters.

In collaboration with the stakeholders above, the departments determined that a reference guide of design practices together with a process to identify and establish a recreational interface with rail lines would be an appropriate approach to the legislative mandate. The agreed upon process for communication between the departments, host railroads and trail stakeholders is detailed in Section 2. This process establishes two opportunities for incorporating trails or pedestrian crossings. The first is through a trail proposal submitted to DCR who will then coordinate with the host railroad. The second is through identifying proposed Rail Enhancement Fund projects and cross-referencing with existing trail proposals, as identified by DCR.

This report was developed to fulfill the requirements of HB2088. The report was reviewed by the various stakeholder groups and provides project development and design considerations for Rails with Trails/Pedestrian Crossings (RWT/PC) along the active right-of-way (ROW) of railroads, with more specific considerations given toward the development of these trails in Virginia. Recreational advocate groups have stated that RWT/PCs and public access alongside or adjacent to active rail lines in the Commonwealth of Virginia could serve as a link to a growing interconnected system of trails that run along the East Coast and through the Commonwealth. Railroad operators, however, have expressed concerns about the safety impacts to rail operations, liability of RWT/PC public access and the impact of liability in the design and decision process. Trail advocate groups believe that Virginia Code §29.1-509 (Virginia Landowner Liability Law) could provide indemnification to the railroads for RWT/PCs. The railroads do not necessarily share the trail advocates' confidence in the

liability law. Outside the purview of this document the Virginia landowner liability law discussion will continue in the future.

The design considerations and proposed process for incorporating recreational uses into new railroad projects presented in this report are for generic application only and intended as conceptual tools to be utilized by recreational or trail advocates, state agencies and host railroads to identify and consider possible applications of public access along active rail lines. No specific right-of-way, train frequencies or speeds are assumed. In addition, this report does not consider potential financial and/or political constraints, or legal and liability issues related to the development of trails along operating railroad ROW. However, the report does discuss in general Virginia's landowner liability law, Virginia Code §29.1-509, and compares to other states with similar provisions.

Contents

This report is divided into two sections.

Section 1 introduces the purpose of the report and involved stakeholders.

Section 2 outlines a course of action to plan, develop and construct an RWT/PC or other recreational access facility. The process by which a trail advocacy group may submit a *Letter of Interest* for a trail proposal is outlined. DCR and/or DGIF will coordinate with DRPT and the host railroad to assess the feasibility of the trail proposal for new Commonwealth supported railroad projects. This section also lists other useful resources for the development of RWT/PCs.

Appendix A is a technical memorandum that reviews possible design considerations for the development of RWT/PC projects. Additional research is presented regarding other states' processes, policies and regulations regarding RWT/PCs, liability, safety and trespass issues. The appendix also summarizes the types of users likely to use the RWT/PC and general considerations for their safety and enjoyment of the RWT/PC facility. Finally, the appendix provides technical design considerations for RWT/PC trail facilities.

Summary

This document was developed as a response to HB2088 and should be used as a common resource for state agencies, railroads, and trail advocates for arriving at a consensus on trail and railroad use. This report establishes a process for RWT/PCs project interface and development. The design considerations presented in this report (as Appendix A) *should not* be considered design guidelines, standards, or specifications. This report provides technical considerations and suggested practices to use as a starting point in the development of these types of facilities.

The Commonwealth assumes no liability in the use or application of the information presented in this report.

1. Introduction

1.1 Purpose and Need

The 2009 Session of the General Assembly, through HB 2088 stated the following:

“No later than December 1, 2009, the Department of Rail and Public Transportation, the Department of Game and Inland Fisheries, and the Department of Conservation and Recreation shall develop a process to coordinate and evaluate public recreational access and safety issues directly related to new railroad projects, if appropriate, that are funded in whole or in part by the Commonwealth, and shall send a report to the Chairmen of the House and Senate Transportation Committees communicating the results.”

In addition to fulfilling this legislative requirement, the purpose of this report is to provide general guidance on project development and design considerations for Rails with Trails and Pedestrian Crossings (RWT/PC) along the active right-of-way (ROW) of railroads, with more specific considerations given toward the development of these types of trails in Virginia. Recreational advocacy groups have stated that RWT/PCs and public access alongside or adjacent to active rail lines in the Commonwealth of Virginia could serve as a link to a growing interconnected system of trails along the East Coast and through the Commonwealth.

Railroad operators, however, have expressed concerns about the safety, impacts to rail operations and liability of public access. Some public activities, when mixed with railroad operations, present hazards for railroads as well as to the public. Switches and signals are sometimes triggered by minimal electric current in actual running rails. If an electrical conductor (an aluminum boat, for instance) were dragged across the track, at not permitted crossing locations, it could complete a circuit and interfere with safe operations and dispatching. In addition, the United States Department of Homeland Security, Transportation Safety Administration (TSA) has raised concerns about the overall safety of the national railroad infrastructure by allowing public access to active rail lines.

Research on both Rails with Trails and Rails to Trails and public access has been completed by public and private organizations. The U.S. Department of Transportation (USDOT) released a report titled *Rails-with-Trails: Lessons Learned* in 2002. That study provides the most comprehensive review of RWT/PC design practices in the United States and worldwide. The USDOT study also serves as the primary source for this report. Where applicable, specific design considerations and other concerns offered by railroads operating in the Commonwealth are also presented.

Developing trails or portions of trails on or near portions of **active** railroad ROW, the issue presented in this report, is quite different from the issue addressed by the National Trails System Act, where railroad operations have ceased. Placing recreational trail users in close proximity to heavy, moving equipment presents safety and liability risks that simply are not present on out-of-service railroad ROW.

1.2 Stakeholder Interests

1.2.1 Railroads

Safety and liability are primary concerns for railroad companies. Both of the major (Class I) railroads in Virginia, Norfolk Southern (NS) and CSX Transportation (CSX), as well as Virginia's shortline railroads have stated that they are opposed to the construction of Rails with trails and at grade pedestrian crossings within the railroad's active ROW. As a general policy, the railroads actively discourage public access to railroad property. Each railroad owner and operator has different approaches to public access, but are willing to address requests set forth through the process outlined in this document on a case-by-case basis.

1.2.2 Recreational Access and Public Crossing Advocates

Recreational access advocates cite many reasons for the development of Rails with Trails. There are currently several initiatives in the Commonwealth for an interconnected system of local, regional and national trail facilities. The East Coast Greenway is one example of a national trail facility. RWT/PCs could potentially serve as a link to other trail facilities that make up the Greenway. When completed, the Greenway will form a trail system extending from Calais, Maine to Key West, Florida. The trail would also pass through Virginia, and recreational advocates have indicated that RWT/PC projects could play a role in this initiative. Rail ROW often travels through scenic locations that are otherwise inaccessible. Recreational advocates also point out that the low frequency and low-volume on some rail lines could make RWT/PCs a safer alternative than trails in proximity to heavily congested highways and streets.

1.3 Limitations of the Report

This document is meant as a common resource for state agencies, railroads, and recreational advocates for arriving at a consensus on trail and railroad use and the pertinent issues for stakeholders. The design considerations presented in this report *should not* be considered design guidelines, standards, or specifications. The USDOT has not developed design guidelines and standards for RWT/PCs. Nor is guidance offered by engineering professional organizations, such as the American Railway Engineering and Maintenance-of-Way Association (AREMA) and the American Association of State Highway and Transportation Officials (AASHTO) for the development of RWT/PCs. These professional organizations have established practices for developing design guidance for their members through committee, which is a process that should be employed in the development of RWT/PCs moving forward.

No specific ROW cross sections or typical sections are assumed, therefore design considerations offered in this report, trail setbacks for example, can only be provided as a range. Constraints along specific rail corridors — and the railroad company's policies towards RWT/PCs (if they exist) — could supersede any design considerations offered in this report.

This report provides technical considerations and suggested practices to use as a starting point in the development of these types of facilities. The Commonwealth assumes no liability in the use or application of this information.

1.4 Recreational Access and Railroad Interface Process

The process begins with a recreational advocacy group submittal of a *Letter of Interest* for a trail proposal to the Virginia Department of Conservation and Recreation (DCR). DCR will then coordinate with the Virginia Department of Game and Inland Fisheries (DGIF), the Virginia Department of Rail and Public Transportation (DRPT) and the host railroad to assess the feasibility of the trail proposal for new Commonwealth supported railroad projects as well as for existing rail lines.

2. Project Interface and Development

2.1 Course of Action for Rails with Trails/Pedestrian Crossing Development

This report presents several of the many steps in the planning process needed to complete an RWT/PC project. Both the Rails-to-Trails Conservancy and USDOT Rails with Trails Studies provide detailed recommendations in the planning process. In summary, these planning steps would include:

- A Project Feasibility Study, including an inventory and assessment of resources
- Stakeholder identification
- Railroad coordination/involvement
- Public involvement
- Legal issues and agreements between stakeholders
- Master planning
- Implementation and construction plans
- Maintenance plans and identification of responsible parties
- Funding sources

2.1.1 Project Feasibility

Feasibility of the project should be established prior to the project initiation, coordination and review process detailed in Section 2.2. Again, this requires an evaluation of corridor specific constraints by trail planners and engineers. The USDOT outlines a methodology for a Feasibility Analysis which is provided in **Figure 2-1**.

Among other issues, a feasibility study serves to identify project constraints. Some of the constraints may be overcome while other constraints may be so cost prohibitive as to negate the possibility of the RWT/PC. Significant constraints can include:

- Number and type of water crossings and/or the presence of tunnels.
- Constrained ROW that would not meet railroad setback, ADA and other safety requirements.
- Rail lines that are considered high-volume “core” lines for existing and future expanded service.
- Numerous or at-grade rail/trail crossings without signals.

Figure 2-1: Steps in an RWT/PC Feasibility Study

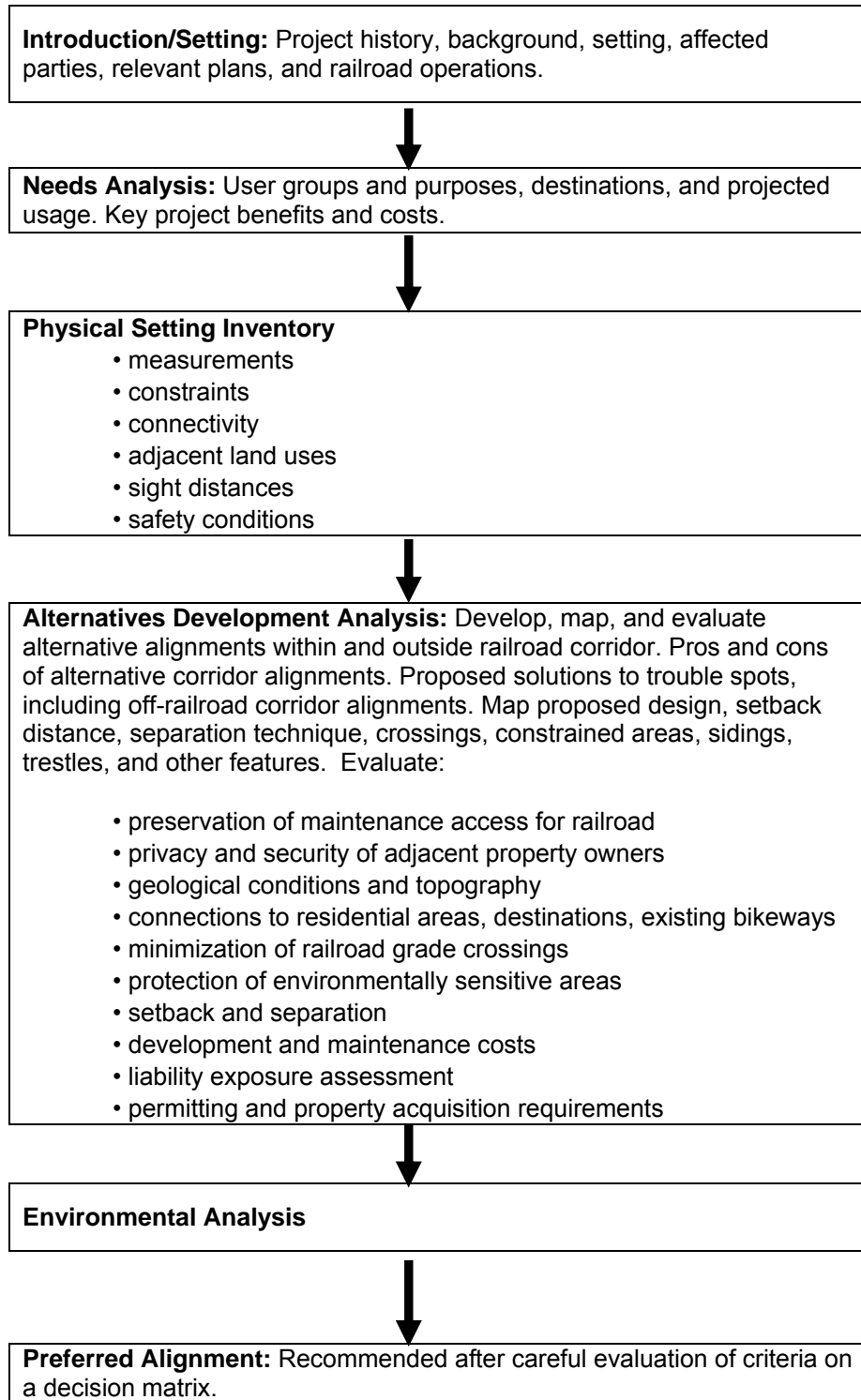

Source: U.S. Department of Transportation, *Rails with trails: Lessons Learned*, 2002, pg. 32

2.1.2 Stakeholder Identification and Outreach

The categorization of trail users is covered in detail in Appendix A and includes:

- Pedestrians
- Bicyclists
- Mountain Bike Users
- Equestrian Users
- Cross-Country Skiers
- Motorized Vehicles
- In-Line Skaters
- Other Passive Users

Another related issue involves public and stakeholder outreach. The Rails-to-Trails Conservancy recommends early and extensive involvement with adjacent landowners to respond to their concerns. Other stakeholders to incorporate into the process include:

- Railroads
- Local, State and Federal Agencies (such as transportation agencies)
- Elected Officials
- Public/Citizen Groups

The Conservancy provides advice for identifying stakeholders, which are defined as individuals or groups which will be impacted by or benefit from an RWT/PC.

Public and stakeholder involvement can be completed with traditional outreach strategies but the Conservancy recommends other approaches, such as one-on-one meetings with individuals (such as concerned landowners); or establishing Citizen/Stakeholder Advisory Committees which can serve to resolve disputes between different parties. Other public involvement techniques include workshops which can address different aspects of the project. A workshop could, for example, present the proposed alignment of the RWT/PC and amenities (A Design Workshop).

2.1.3 Master Planning

Master planning of the RWT/PC is similar in approach to other planning process; the Conservancy recommends that a trail plan document provide:

- A Site Assessment
- The Vision, Goals and Objectives of the RWT/PC
- Routing/Design/Alignment (with maps)
- Implementation Strategies

The plan should also address how the RWT/PC fits with the region's master trail plan or comprehensive plan.

2.1.4 Implementation Plans

Implementation plans are carried out last in the trail development process. As the Conservancy recommends, this type of plan should outline:

- Activities necessary for acquiring easements, ROW, or land for the RWT/PC
- Identify necessary railroad, local, state, and federal permits and approvals
- Prepare final design and construction bidding documents
- Obtain funding for any land acquisition, design, construction and maintenance of the RWT/PC

2.2 ***Rails with Trails/Pedestrian Crossing Project Initiation, Coordination and Review***

The Class I and shortline railroads operating in Virginia have requested that Rails with trails proposals be coordinated and submitted for review through a single state agency. The Virginia Department of Conservation and Recreation (DCR) is the state agency responsible for initial review of public requests for RWT/PCs. The process for submitting a trail proposal to the DCR is outlined below.

2.2.1 **Rails with Trails/Pedestrian Crossing Proposal Submission for Existing Rail Lines**

Recreational trail advocates interested in developing a RWT/PC project in the Commonwealth of Virginia must first submit a *Letter of Interest (LOI)* to the Virginia Department of Conservation and Recreation (DCR). The LOI will precede a formal application or comprehensive trail planning process, and will allow the trail advocate(s) to assess the preliminary feasibility of the project from the railroad operator's perspective. While not all rail corridors may be suitable for trail projects, the LOI is an important first step, without a major commitment of time and resources that a comprehensive trail planning process would require.

The LOI will address several topics, which will be used to evaluate the initial feasibility of the project:

1. The termini of the proposed trail project. These locations may be expressed as mileposts, geographic coordinates, or other easily noted locations such as highway crossings.
2. A 7.5' USGS Quad Map(s) with an illustrative sketch of the proposed trail alignment. Other topographic mapping on a scale of 1 inch=2,000 feet may be used as well.
3. Name of the operating railroad and maps of railroad ownership in project area.
4. Geographic extent of the project (county or counties that encompass the project).
5. Anticipated sources and status of funding for both construction and maintenance.
6. Estimated project cost (if known).
7. The target group of trail users, e.g. pedestrians, bicyclists, equestrian users, etc.
8. Sponsoring trail advocacy group or jurisdiction, and name of entity who would own, operate and maintain the trail.
9. Name and title of applicant contact.

Prior to submittal of the LOI, it is strongly encouraged that the applicant(s) review guidance provided in the Process for Evaluating Recreational Access Railroad Interface in the Commonwealth of Virginia, and guidelines of the host railroad. The process was developed by the Virginia Department of Rail and Public Transportation (DRPT), Department of Conservation and Recreation (DCR) and Department of Game and Inland Fisheries (DGIF) in consultation with Virginia railroads and trail stakeholders. This report is available online at www.drpt.virginia.gov, www.dcr.virginia.gov and www.dgif.virginia.gov. This report identifies several factors which should be considered in evaluating the feasibility of a RWT/PC.

Once the LOI is reviewed and preliminarily accepted by DCR, DCR will then coordinate with the operating railroad for the potential development of a RWT/PC. DCR will also contact DGIF and DRPT to advise of the LOI.

The sequence for the review process consists of the following:

1. Applicant submits the LOI to DCR for review.
2. DCR reviews LOI and contacts applicant if clarifications are required (within 60 days).
3. DCR submits LOI to the railroad operator/ROW owner for consideration with a copy to DRPT.
4. DCR provides trail advocate(s) and DRPT with a written response detailing the railroad's decision to continue consideration of the trail/crossing proposal or to decline the proposal. If the railroad declines, the process ends. Future resubmission is permitted if the project parameters changes.
5. If the railroad does not disapprove the project as proposed in the LOI, the DCR will notify the applicant and DRPT. The railroad will at this point, notify DCR for any required conditions that must be met to proceed through the trail planning process. DCR will forward such conditions to the applicant.
6. The applicant may then decide to advance the project by preparing a formal trail plan which is then submitted to the DCR.
7. The formal trail plan should include at a minimum:
 - a. The engineered solution to safety and design issues as identified by the railroad
 - b. Potential alternatives
 - c. Signing plan
 - d. Maintenance and operations plan
8. The formal trail plan is last reviewed by a state designated Review Committee. The Committee is made up of representatives of DRPT, DCR, DGIF and the host railroad (rotating). The Committee shall also include up to 2 members of access advocacy groups within the Commonwealth.
9. The Review Committee will issue a recommendation on the trail/crossing proposal, which will then be submitted to the railroad to render a final decision.

LOI Submittal

The LOI should be submitted to:

Planning Bureau Manager
Virginia Department of Conservation and Recreation
203 Governor Street, Suite 326
Richmond, VA 23219

2.2.2 Process for Considering Rails with Trails/Pedestrian Crossings for new Rail Projects Funded with Rail Enhancement Funds

During the Rail Enhancement Fund (REF) application period DRPT will notify DCR of the applications received. DCR, DGIF and DRPT will undertake a review of REF applications and conduct a screening for the applicability and feasibility of a RWT/PC in conjunction with the proposed rail project. Trail proposals will not delay the REF funding and project development process. The sequence for the review process is as follows:

1. DRPT prepares announcements of the REF application period and requests applications. Information is also posted on the DRPT website. Applicants for rail projects must submit applications within the advertisement period as identified by DRPT.
2. Upon receipt of applications, DRPT will review the REF applications and post them on the DRPT Rail Advisory Board website for review.
3. DCR will review existing RWT/PC proposals on file. DCR and DGIF will also cross reference their files/databases of existing/future parks, trails and boat launches for applicability and feasibility of establishing a RWT/PC to link existing or future recreational facilities in connection with a project application (within 30 days of DRPT posting).
4. Where DCR and/or DGIF find an applicable and feasible RWT/PC proposal in their files/databases, DCR will identify and work with an appropriate recreational or trail advocate group to be a sponsor of a RWT/PC proposal submission. The proposal submission will follow the procedures above.
5. If a RWT/PC proposal is found to be applicable within an REF proposed project area, DRPT, in coordination with DCR and DGIF, will work with the REF applicant and any affected railroads to establish whether a RWT/PC may be feasible.
6. If a trail or pedestrian crossing is determined to be worthy of further consideration, a Letter of Intent (LOI) is submitted by the project sponsor to DCR. The LOI process described above and detailed in the RWT/PC proposal submission will then be followed.

Based on the REF application review and project selection criteria, DRPT will develop rail project recommendations for the Rail Advisory Board (RAB). The RAB reviews the projects and makes recommendations to the Commonwealth Transportation Board (CTB). The CTB will approve and allocate REF funds to specific eligible projects in the Six-Year Improvement Plan (SYIP).

7. The Code of Virginia does not allow for the use of Rail Enhancement Funds for RWT/PC projects. Therefore, funding for the RWT/PC projects must be provided by funds other than REF funds. REF funded projects will advance without delay as the RWT/PC project is being negotiated.

2.3 Legal Issues

Liability, access easements, and other legal issues associated with RWT/PC will need to be addressed by all stakeholders—the trail advocates and owners, the host railroads, and the Commonwealth of Virginia. Issues of liability must be addressed separately from the technical guidance presented in this report.

While, technically, unlawful activity (trespassing on railroad property) was at the root of 426 injuries and 458 fatalities on United States railroad property in 2008, railroads, as potentially liable landowners, expressed a desire to minimize such incidents.¹

Many other states have legislation which relates to the development of an RWT/PC project, including limited liability statutes. Other states which have some type of a limited liability statute for trails include Alaska, Georgia, Hawaii, Indiana, New Hampshire, New Mexico, North Carolina and Pennsylvania.²

In addition to building actual structures to isolate rail lines, some states have enacted landowner liability laws. One such law, passed in Maine in 2005, has given landowners—from local farmers to nationwide railroad corporations—a large degree of protection from lawsuits related to injuries on their property.³ It discourages lawsuits in two ways. First, the law is worded to protect landowners so directly that injured parties perceive little opportunity to build winning cases. Additionally, should a plaintiff lose, he or she must pay the defendant's (i.e. the landowner's) legal fees and court costs.⁴

At one point, however, Maine's limited liability statute is slightly ambiguous—it does not protect “malicious” landowners.⁵ Maliciousness, as defined in the law, does not require conscious desire to harm trespassers. Rather, malicious intent can be *inferred* if landowners knowingly neglect to warn against a dangerous situation.⁶ The long-term effects of Title 14 on Maine's railroad companies remain to be seen, however no citizen has won a “landowner liability” personal injury case since this law was passed.

The Pennsylvania Legislature, in 2004, passed a statute aimed specifically at railroad property. Known as the “Railroad Trespass Statute,” it facilitated the process for holding individuals accountable for trespassing if such acts occurred on railroad ROW. It reinforces Pennsylvania law allowing recreational crossing of tracks (perpendicularly) but specifies that any pedestrian movement along tracks (longitudinally) is illegal. Not only are Pennsylvania's railroad trespass penalties stricter than its general trespass laws but, under this statute, they can also be imposed on perpetrators of other rail-related crimes (e.g. jumping onto rail cars, or vandalism). As with Maine's Title 14, the success of Pennsylvania's trespass statute cannot yet be determined. It may reach its peak of effectiveness when police officers and magisterial judges statewide understand that railroad crimes have been increased to a third degree misdemeanor.

¹ Operation Lifesaver, *2008 Statistics by State: Crossing Collisions and Casualties, Trespass Casualties*.

² United States Department of Transportation, *Rails with trails: Lessons Learned*, August 2002, pg. 113.

³ Maine Landowner Relations Program, *Landowner Liability Law Explained*, 2008.

⁴ Maine Title 14, §159-A, *Limited liability for recreational or harvesting activities*.

⁵ Brown, Tommy L. *Analysis of Limited Liability Recreation Statutes in the Northern Forest States*. Cornell University, October 2006.

⁶ Maine Landowner Relations Program, 2008.

Virginia's Landowner Liability Law (Virginia Code § 29.1-509) attempts to address this issue as well. Similar to Maine's liability law, the protection to landowners does not protect from malicious or grossly negligent actions. Also, protection is not afforded to landowners who charge a fee for usage or for an easement. However if the landowner enters into an agreement with the Commonwealth (state agency) for recreational access the agency is obligated to hold the landowner harmless and is responsible for providing the legal expenses of a landowner in the event a case is filed. Since its inception the Virginia landowner liability law has not been utilized or tested in a court of law. The railroads feel that this provision does not adequately address potential risks due to the unique conditions of existing railroad use arrangements.

2.4 Additional Resources

Primary sources for this report have been mentioned throughout. Other general trail planning and design resources include:

- Regional Pedestrian and Bicycle Plans (Metropolitan Planning Organizations)
- U.S. Department of Transportation (USDOT), Rails with trails: Lessons Learned, Literature Review, Current Practices, Conclusions, 2002 (<http://www.fhwa.dot.gov/environment/rectrails/rwt/>)
- The Virginia Bicycle Facility Resource Guide (<http://www.virginiadot.org/programs/bk-default.asp>)
- The Virginia Department of Transportation (VDOT) Road Design Manual, last revised September 2005.
- American Association of State Highway and Transportation Officials (AASHTO), Guide for the Development of Bicycle Facilities, 3rd Edition (www.aashto.org)
- Rails-to-Trails Conservancy, Trails for the Twenty-First Century, Second Edition, 2001 (www.railstotrails.org).
- Rails-to-Trails Conservancy, Design, Management and Operating Characteristics of 61 Trails Along Active Railroads, 2000 (www.railstotrails.org).
- American Railway Engineering and Maintenance-of-Way Association (AREMA), Manual for Railway Engineering, 2002 (www.arema.org)
- Americans with Disabilities Act (ADA), ADA and ABA Accessibility Guidelines, 2004
- CSXT Transportation, Public Project Information for Construction and Improvement Projects that may involve the Railroad, 2005 (www.csx.com)
- Norfolk Southern Corporation, Guidelines for Design of Grade Separation Structures (www.nscorp.com)
- National Park Service (www.nps.gov)
- American Society of Landscape Architects (ASLA) (www.asla.org)
- American Planning Association (APA) (www.planning.org)
- Virginia State Pedestrian and Bicycle Plans (www.virginiadot.org/infoservice/bk-default.asp)

Appendix A

Design Considerations for the Establishment of Rails with Trails/Pedestrian Crossings in the Commonwealth of Virginia

Technical Memorandum

Design Considerations for the Establishment of Rails with Trails/Pedestrian Crossings in the Commonwealth of Virginia

Technical Memorandum

November 2009



Table of Contents

1. Introduction	1
1.1 Purpose and Need.....	1
1.2 Contents.....	1
1.3 Limitations of the Report.....	2
2. Existing Design Guidance	3
2.1 Introduction.....	3
2.2 United States Department of Transportation (USDOT).....	4
2.3 Virginia Department of Transportation (VDOT).....	4
2.4 American Association of State Highway and Transportation Officials (AASHTO).....	6
2.5 American Railway Engineering and Maintenance-of-Way Association (AREMA).....	6
2.6 Americans with Disabilities Act (ADA).....	6
2.7 Other Design Guidance.....	8
2.7.1 CSXT Railroad.....	8
2.7.2 Norfolk Southern Railway (NS).....	8
2.7.3 Shortline Railroads.....	9
2.7.4 Rails-to-Trails Conservancy.....	9
2.8 Applicability to Rails With Trails/Pedestrian Crossing Projects with ROW Constraints.....	9
3. Types of Trails	10
3.1 Introduction.....	10
3.2 Types of Trails and Users.....	10
3.2.1 Pedestrian Trails.....	10
3.2.2 Bicycle and Shared-Use Paths.....	11
3.2.3 Mountain Bike Users.....	11
3.2.4 Equestrian Users.....	11
3.2.5 Cross-Country Skiers.....	12
3.2.6 Motorized Vehicles.....	12
3.2.7 In-Line Skaters.....	12
3.2.8 Other Users.....	12
3.3 Considerations for Developing Trails.....	13
3.3.1 Trail Access Points.....	13
3.3.2 Trail Connections.....	13
3.3.3 Adjacent Landowner Concerns.....	14
4. Design Considerations	15
4.1 Introduction.....	15
4.2 Clearances.....	15
4.2.1 Trail Setback Distances.....	15
4.2.2 Vertical Clearance.....	18
4.2.3 Separations.....	18
4.3 Maintenance-of-Way (MOW).....	20
4.3.1 Tie Renewal.....	20
4.3.2 Ballast Maintenance.....	21
4.3.3 Rail Grinding.....	21
4.3.4 General Inspection of Track and Facilities.....	21
4.3.5 Rail Replacement.....	22
4.3.6 Vegetation Control.....	22
4.3.7 Emergency Repair.....	22
4.3.8 Bridge Maintenance.....	23

4.3.9	Signal Facility Maintenance	23
4.3.10	Other Maintenance Activities	23
4.4	Security Patrols	23
4.5	Emergency Response	24
4.6	Train Operations.....	24
4.7	Structures.....	24
4.7.1	Bridges/Trestles.....	24
4.7.2	Tunnels	26
4.8	At-Grade Rails with Trails/Pedestrian Crossings.....	26
4.8.1	At-Grade Highway Crossings.....	26
4.8.2	At-Grade Rail/Trail Crossings	28
4.9	Grade-Separated Rails with Trails/Pedestrian Crossings.....	29
4.10	Associated Facility and Trail Costs.....	31
4.11	Constrained ROW Issues.....	32

List of Figures

Figure 2-1:	Cross-Section for a Shared Use Path (VDOT).....	5
Figure 2-2:	Minimum Clear Widths.....	7
Figure 2-3:	Minimum Clear Widths at Turns.....	7
Figure 4-1:	Setback Distance Defined.....	16
Figure 4-2:	Setback Range	16
Figure 4-3:	Setbacks-Constrained Section.....	17
Figure 4-4:	Setback-Fill Section	17
Figure 4-5:	Clearance	18
Figure 4-6:	Separation Technique using Vegetation	19
Figure 4-7:	Trestle Option 1	25
Figure 4-8:	Trestle Option 2	25
Figure 4-9:	At-Grade Highway Crossing Option 1	27
Figure 4-10:	At-Grade Highway Crossing Option 2	27
Figure 4-11:	At-Grade Rail Crossing with Passive Warning Devices.....	28
Figure 4-12:	At-Grade Rail Crossing with Active Warning Devices	28
Figure 4-13:	90° At-Grade Rail Crossing (No Warning Devices)	29
Figure 4-14:	Underpass	29
Figure 4-15:	Underpass (Culvert).....	30
Figure 4-16:	Overpass (Detail).....	30
Figure 4-17:	Overpass (Minimum Clearance)	30

List of Tables

Table 2-1:	Active RWT/PCs along Class I Railroads.....	3
Table 2-2:	VDOT Design Guidelines Summary for a Shared Use Path.....	5
Table 4-1:	General Reference –Associated Facility Estimated Unit Costs	31
Table 4-2:	Reference Unit Costs for Trail Development	32

List of Photos

Tie Renewal.....	20
Ballast Maintenance	21
Vegetation Control.....	22

1. Introduction

1.1 Purpose and Need

In conjunction with fulfilling legislative requirement of HB 2088, the purpose of this report is to provide general guidance on project development and design considerations for Rails with Trails/Pedestrian Crossing (RWT/PC) projects along the active right-of-way (ROW) of railroads.

Research on both Rails with Trails and Rails to Trails and public access has been completed by public and private organizations. The U.S. Department of Transportation (USDOT) released a report titled *Rails-with-Trails: Lessons Learned* in 2002. That study provides the most comprehensive review of RWT/PC design practices in the United States and worldwide. The USDOT study also serves as the primary source for this report. Where applicable, specific design considerations and other concerns offered by railroads operating in the Commonwealth are also presented.

The design considerations and proposed process for incorporating recreational uses into existing and new railroad projects presented in this report are for generic application only and are intended as conceptual tools to be utilized by recreational or trail advocates, state agencies and host railroads to identify and consider possible applications of public access along active rail lines. No specific ROW, train frequencies or speeds are assumed.

1.2 Contents

This report is divided into four sections.

Section 1 introduces the purpose of this document and how it relates to HB 2088.

Section 2 discusses the applicability of other technical references useful for the development of RWT/PC projects. These references include the *Rails-with-Trails: Lessons Learned Study* developed by the USDOT. The American Association of State Highway and Transportation Officials (AASHTO) and Americans with Disabilities Act (ADA) guidance are particularly noted for the relevance in the *Rails-with-Trails: Lessons Learned Study*. Additional research is displayed regarding other states processes, policies and regulations regarding RWT/PCs, liability, safety and trespass issues.

Section 3 summarizes the types of users likely to use the RWT/PC and general considerations for their safety and enjoyment of the RWT/PC facility. This information is summarized from the *Trails for the Twenty-First Century Study*. That study, produced by the Rails-to-Trails Conservancy focuses on Rails to Trails. Although, certain aspects of the Conservancy's research are relevant to Rails with Trails projects.

Section 4 provides technical design considerations for RWT/PC trail facilities. This section uses the *Rails-with-Trails: Lessons Learned Study* as a primary source. Issues addressed in the section include:

- Considerations for vertical and horizontal clearances on RWT/PCs
- Separation techniques for the railroad and trail

- Maintenance-of-way issues
- Structures, particularly options for water crossings
- Design considerations for at-grade and grade-separated crossings
- Associated facilities/trail amenities and order of magnitude costs and needs

1.3 Limitations of the Report

This document was developed as a common resource for state agencies, railroads, and recreational advocates for arriving at a consensus on trail and railroad use and the pertinent issues for stakeholders. The design considerations presented in this report *should not* be considered design guidelines, standards, or specifications. The USDOT has not developed design guidelines and standards for RWT/PCs. Nor is guidance offered by engineering professional organizations, such as the American Railway Engineering and Maintenance-of-Way Association (AREMA) and AASHTO for the development of RWT/PCs. These professional organizations have established practices for developing design guidance for their members through committee, which is a process that should be employed in the development of RWT/PCs moving forward.

No specific ROW cross sections or typical sections are assumed, therefore design considerations offered in this report, trail setbacks for example, can only be provided as a range. Constraints along specific rail corridors — and the railroad company's policies towards RWT/PCs (if they exist) — could supersede any design considerations offered in this report.

This report is not advocating the development of RWT/PCs, but rather provides technical considerations and suggested practices to use as a starting point in the development of these types of facilities. The Commonwealth assumes no liability in the use or application of the information presented in this report.

2. Existing Design Guidance

2.1 Introduction

Although a standard set of technical guidance does not exist for RWT/PC there are several resources which are useful:

- U.S. Department of Transportation (USDOT), *Rails-with-Trails: Lessons Learned, Literature Review, Current Practices, Conclusions*, 2002
- The Virginia Department of Transportation (VDOT) *Road Design Manual*, last revised September 2005.
- American Association of State Highway and Transportation Officials (AASHTO), *Guide for the Development of Bicycle Facilities, 3rd Edition*
- Rails-to-Trails Conservancy, *Trails for the Twenty-First Century, Second Edition*, 2001.
- Rails-to-Trails Conservancy Northeast Regional Office, *Rail-Trail Maintenance & Operation*, July 2005.
- American Railway Engineering and Maintenance-of-Way Association (AREMA), *Manual for Railway Engineering*, 2002
- Americans with Disabilities Act (ADA), *ADA and ABA Accessibility Guidelines*, 2004
- CSXT Transportation, *Public Project Information for Construction and Improvement Projects that may involve the Railroad*, 7/22/05
- Norfolk Southern Corporation, *Guidelines for Design of Grade Separation Structures*
<http://www.nscorp.com> (Website)

This section discusses the applicability of these technical references to RWT/PC projects. AASHTO and ADA guidance are particularly noted for the relevance in the *Rails-with-Trails: Lessons Learned Study*.

The *Lessons Learned Study* also provides examples of active Rails with Trails with United States. In the Eastern United States, examples of RWT/PCs can be found along several operating Class I rail corridors. **Table 2-1** lists these examples.

Table 2-1: Active RWT/PCs along Class I Railroads

Trail Name	Corridor Owner	Railroad Operation	Location
Arboretum Trail*	Norfolk Southern	Unknown	Pennsylvania
Cedar Lake Trail	Burlington Northern Santa Fe	Burlington Northern	Minnesota
Celina/Coldwater Bike Trail	Norfolk Southern	RJ Corman	Ohio
Columbus Riverwalk	Norfolk Southern	Railtex/GATX/Georgia Southwestern Railroad Company	Georgia
Eastbank Esplanade/Steel Bridge Riverwalk	Union Pacific	Union Pacific, Amtrak	Oregon
Elk River Trail	Norfolk Southern	Norfolk Southern	West Virginia
Gallup Park Trail	Norfolk Southern	Norfolk Southern	Michigan

Trail Name	Corridor Owner	Railroad Operation	Location
Huffman Prairie Overlook Trail	CSX	CSX and Grand Trunk Western	Ohio
Schuylkill River Trail	Norfolk Southern (3.2 km/2 mi)	Norfolk Southern	Pennsylvania
Stavich Bicycle Trail	CSX	CSX	Ohio and Pennsylvania
Union Pacific Trail	Union Pacific	Union Pacific	Colorado
Zanesville Riverfront Bikepath	Norfolk Southern	CSX and Norfolk Southern	Ohio

Source: U.S. Department of Transportation, *Rails-with-Trails: Lessons Learned*, 2002

2.2 United States Department of Transportation (USDOT)

The *Rails-with-Trails: Lessons Learned Study* is currently the most comprehensive source of known information on this topic for the development of RWT/PCs in the United States. The study covers a range of issues facing trail developers including legal, design and operational issues. The study also highlights case studies for RWT/PCs in operation.

As mentioned in the previous chapter, this report primarily references the USDOT study for design considerations. Since there are no existing standards or guidelines on RWT/PC facility design, the USDOT collected information over three years, from sources around the world.

The USDOT study recommends that RWT/PCs projects be evaluated through a Feasibility Study which will address several issues including:

- Relationship to existing local, regional, and state plans
- Land ownership patterns along the proposed RWT/PC corridor
- Railroad activity
- Constraints to the development
- Preferred and alternative alignments for the RWT/PC

2.3 Virginia Department of Transportation (VDOT)

VDOT annually maintains the *Road Design Manual* for transportation facility construction within the Commonwealth. In addition to highway and roadway specifications, the manual also offers technical guidance for the development of four types of bicycle facilities:

- Shared Roadway (No Bikeway Designation)
- Signed Shared Roadway
- Bicycle Lane
- Shared Use Path

VDOT notes in the manual that AASHTO guidelines are used as the primary source and minimum criteria in developing the manual. Most applicable to RWT/PCs are the *Shared Use Path* type of bicycle facility. A Shared Use Path is defined by VDOT as a facility with “exclusive right-of-way and minimal cross flow by motor vehicles.” **Table 2-2** summarizes the design guidelines offered by VDOT for this type of facility. **Figure 2-1** is also taken from the VDOT Manual, illustrating a cross-section for a Shared Use Path.

Table 2-2: VDOT Design Guidelines Summary for a Shared Use Path

	Guideline
Separation	Minimum 5 feet or physical barrier
Barrier Height	Between 42 to 54 inches minimum
Trail Width – two-directional path	10 feet (12 to 14 feet recommended for heavy use)
Trail Width – one-directional path (not recommended)	6 feet
Surface	Pavement
Design Speed (bicycles)	20 mph minimum 30 mph minimum (4 percent grades)
Horizontal Alignment	2 to 3 percent (based on ADA guidelines)
Grade (Maximum Distance)	800 feet (at 5 percent) to 50 feet (at 11+ percent)
Sight Distances	Refer to Tables A-5-9 and A-5-10 in VDOT Manual

Figure 2-1: Cross-Section for a Shared Use Path (VDOT)

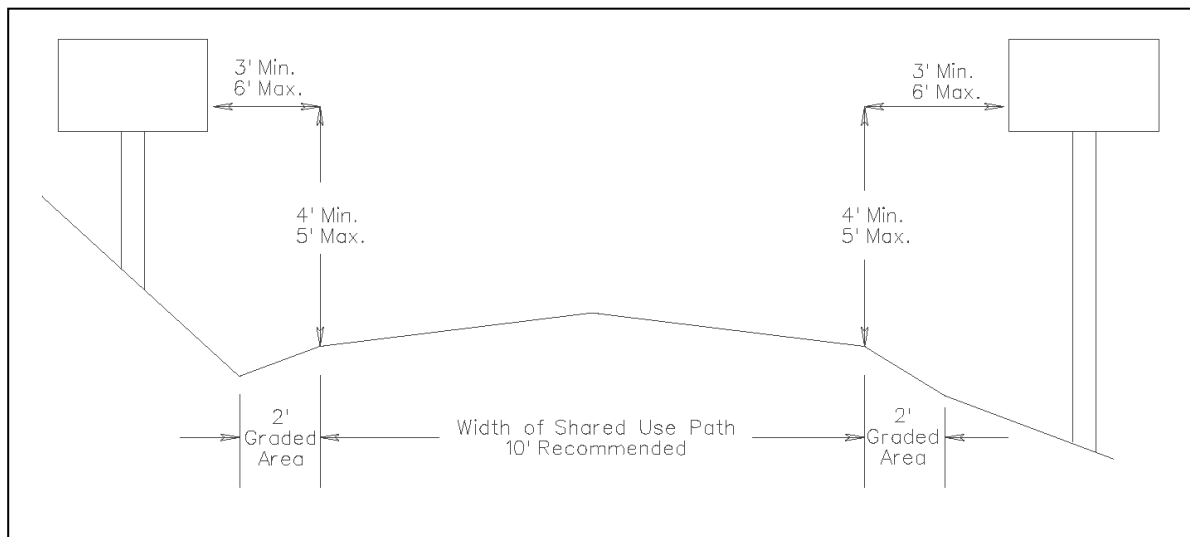

Source: Virginia Department of Transportation, *Road Design Manual*, Revised Sept. 2005, pg. A-87

The complete design guidelines for Shared Use Path Bicycle Facilities are available in the manual which can be accessed online.¹ Additionally, VDOT publishes a *Bicycle Facility Resource Guide*² which provides information on planning, designing, and funding a bicycle trail in the Commonwealth.

¹ <http://www.extranet.vdot.state.va.us/locdes/Electronic%20Pubs/2005%20RDM/appenda.pdf>.

² <http://www.virginiadot.org/travel/resources/bk-facresguide.pdf>

2.4 American Association of State Highway and Transportation Officials (AASHTO)

AASHTO continually develops and revises design guidelines for bicycle facilities. The *Guide for the Development for Bicycle Facilities* was last revised in 1999, and provides technical guidance for developing a range of bicycle facilities, including shared use paths. AASHTO differentiates shared use paths from trails by more carefully describing trails as *unimproved* recreational facilities. Shared use paths are usually paved and maintained by a state or local governmental agency. These types of bicycle facilities are defined further as exclusive ROW facilities with “minimal cross flow of motor vehicles.” Additionally, shared use paths are intended for non-motorized purposes. These types of facilities are not intended for use by motorized vehicles such as snowmobiles, ATVs, etc.

2.5 American Railway Engineering and Maintenance-of-Way Association (AREMA)

The American Railway Engineering and Maintenance-of-Way Association (AREMA) produces a multi-volume series of technical guidelines for engineers. The *Manual for Railway Engineering* does not provide guidance for the development RWT/PC facilities but does provide guidance in these areas:

- Vertical and horizontal clearances for railroads
- Maintenance-of-way practices
- Development of maintenance-of-way facilities
- Associated track facilities needed for the railroad’s operation

AREMA states that these guidelines are often railroad specific, and it is also logical to use CSXT and Norfolk Southern specific guidelines in the above areas (where they exist).

2.6 Americans with Disabilities Act (ADA)

The Americans with Disabilities Act of 1990 is:

“A major civil rights law prohibiting discrimination on the basis of disability, establishes design requirements for the construction or alteration of facilities. It covers facilities in the private sector (places of public accommodation and commercial facilities) and the public sector (state and local government facilities).”³

Although there are no specific design standards for rails with trails in the Act, it is assumed that guidelines would apply to these types of trail facilities. The most current design guidelines (2007) define trail facilities as accessible routes. Accessible routes include both indoor and recreational paths, and must meet design standards for:

- Slip-resistant ground surfaces
- Slopes with a ratio of no more than 1:20 for walking surfaces, and cross-slope walking surfaces ratios of no more than 1:48
- Clear widths of a minimum of 32 to 36 inches (See Figure 2-2)
- Clear widths at turns (See Figure 2-3)

³ Source: United States Access Board, Accessed at <http://www.access-board.gov/ada-aba/summary.htm>

Figure 2-2 provides an illustration of the minimum clear widths expected under ADA guidelines. Figure 2-3 illustrates clear widths at turns. Although these figures illustrate an enclosed setting, the standards are equally applicable to recreational facilities according to the regulation.

Figure 2-2: Minimum Clear Widths

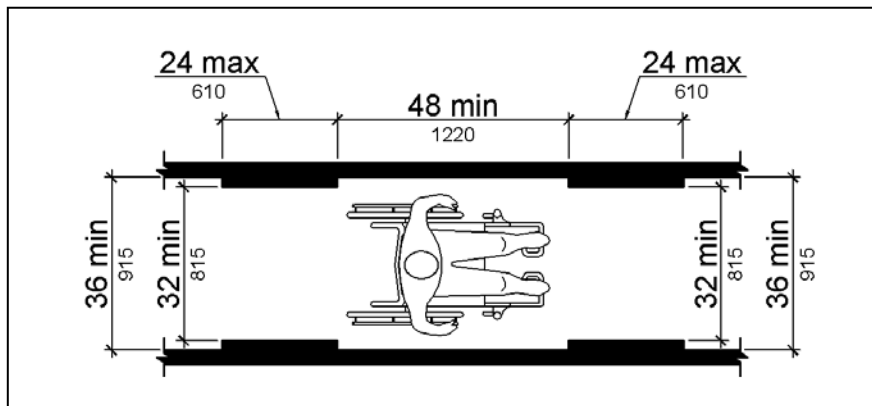
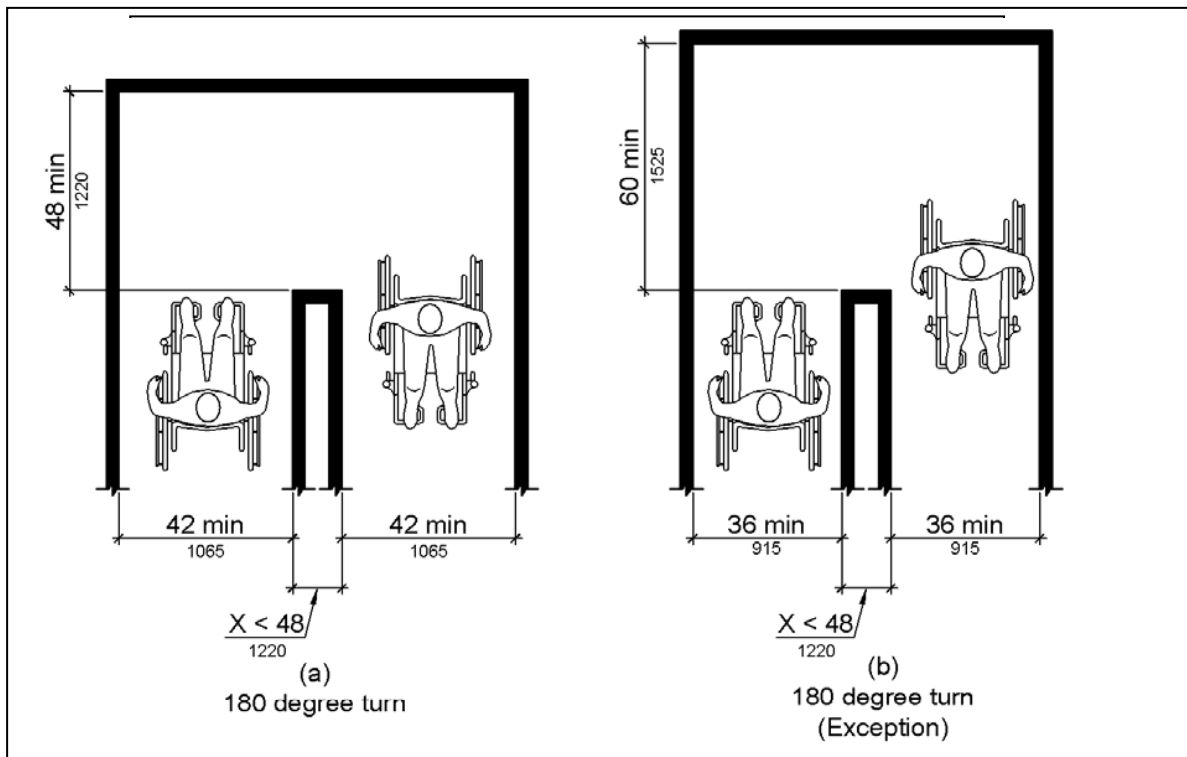

Figure 2-3: Minimum Clear Widths at Turns



Source: United States Access Board, *ADA and ABA Accessibility Guidelines for Buildings and Facilities*, p. 155

Trail widths recommended by AASHTO are more than double the minimum ADA standards, but the ADA guidelines must be considered when evaluating the feasibility of RWT/PC projects, particularly within constrained ROW. Additional ADA design standards information can be accessed online.⁴

2.7 Other Design Guidance

2.7.1 CSXT Railroad

CSXT recognizes that communities often wish to establish recreational paths in areas adjacent to active railroad lines. Understanding the importance of these activities to local communities, CSXT has developed a *Public Project Information (For Construction and Improvement Projects that May Involve the Railroad) Manual*⁵ which provides general policy guidance on the development of bicycle/pedestrian “parallel paths” and crossings on CSXT ROW. CSXT states that employee and public safety is paramount in the development of parallel pathways on CSXT ROW. As a matter of policy, CSXT states that:

- Private or public parallel at-grade paths are not permitted on active CSXT ROW.
- CSXT will oppose condemnation proceedings aimed at recreational use of trackside property.
- Bicycle/pedestrian pathways cannot cross tracks at-grade.
- Public agencies or private landowners that establish bike/pedestrian path usage of trackside property must provide unqualified indemnity and adequate insurance.
- CSXT requires the public agency or private landowner to bear the costs of installation and maintenance of any safety measures, such as fencing and signage, that may be necessary to eliminate or lessen risks.

Specific technical guidance for the development of grade-separated RWT/PCs is not provided by CSXT through their manual or website, www.csx.com. General guidance is provided for the enhancement of safety including:

- Fencing
- Signage
- Installation, inspection and maintenance costs

CSXT notes that there may be conditions where existing highway/rail easements would allow for pedestrian/bicycle at-grade crossings, and that all appropriate safeguards should be made including the installation of signs and warning systems for pedestrians and bicyclists at the crossings. CSXT expects the installation and maintenance of this equipment to be paid by the party or government agency developing the RWT/PC project.

2.7.2 Norfolk Southern Railway (NS)

NS provides information for the design and construction of grade-separated structures. Specific guidance for the development and construction of RWT/PCs on NS ROW is not provided on the company’s website, www.nscorp.com. Discussions with NS have indicated that they review RWT/PC proposals within NS ROW on a case-by-case basis.

⁴ <http://www.access-board.gov/ada-aba/final.pdf>

⁵ http://www.csx.com/share/media/media/docs/CSX_Public_Project_Manual-REF21857-REF22268.pdf

2.7.3 Shortline Railroads

The Virginia shortline railroads have not developed policies or guidelines for design. However they may utilize the Class I railroads design guidelines based on lease agreements in place. Any design will be handled on a case-by-case basis.

2.7.4 Rails-to-Trails Conservancy

Although the Rails-to-Trails Conservancy has focused trail development on *abandoned* railroad ROW, their publication, *Trails for the Twenty-First Century* is also informative for development of RWT/PCs. This study is particularly relevant for identifying and designing trails for different types of trail users. There are obviously different considerations with rails to trails projects however, where at-grade and water crossings (for example) do not present the safety issues that are present on active railroad lines. For example, active railroad lines present safety concerns to trail users such as the risk of falling debris or injury from shifted cargo (e.g. logs) or equipment used to secure cargo (e.g. chains and straps).

The 2000, *Rails with Trails – Design Management and Operating Characteristics of 61 Trails Along Active Rail Lines* report addresses findings on rails with trails safety.⁶

2.8 Applicability to Rails With Trails/Pedestrian Crossing Projects with ROW Constraints

The feasibility of a RWT/PC project is largely dependent on ROW constraints. There are certain features along a ROW where a RWT/PC would be highly impractical and/or very costly to develop. One example would be sections along ROW where horizontal clearance is less than 36 inches (when taking minimum setbacks into consideration), and in situations where AASHTO guidance is used, and less than 14 feet is available for the trail and drainage.

CSXT follows policy that will affect the feasibility of constructing along constrained CSXT ROW. The railroad indicates that it would not “permit parallel at-grade paths” that generally lie within the railroad’s ROW. NS has also indicated that they would not allow pedestrian pathways within railroad ROW. CSXT also states that rail/trail crossings “cannot” cross tracks at-grade, unless at an existing public at-grade roadway crossing.

These requirements are likely to present significant constraints to the development of a RWT/PC, except where railroad requirements can be waived or accommodated. Accommodation could take the form of grade separated crossings, either existing or planned.

⁶ *Rails With Trails – Design, Management, and Operating Characteristics of 61 Trails Along Active Rail Lines*, Rails to Trails Conservancy and the National Park Service, 2000, pg. 6.

3. Types of Trails

3.1 Introduction

Trail planners should identify the types of users early in the planning process. The types of trail users can emerge through a public input process, and it is also likely that the RWT/PC will serve multiple types of users. In addition, there is also the danger of any user wandering off-trail and onto the railroad tracks; obviously this practice should be actively discouraged.

Section 3.2 summarizes the types of users likely to use the RWT/PC and general considerations for their safety and enjoyment of the trail facility. This information is summarized from the *Trails for the Twenty-First Century* study. That study, produced by the Rails-to-Trails Conservancy (The Conservancy), focuses on rails to trails, although certain aspects of their research are as relevant to RWT/PC projects. In relation to identifying specific types of trail users, the Conservancy study notes that the identification of expected trail users will assist in developing:

- Trail widths
- Vertical clearances needed for a trail
- Surface material used for a trail
- Trail amenities

3.2 Types of Trails and Users

3.2.1 Pedestrian Trails

Pedestrians include walkers, hikers, joggers, runners, parents with baby strollers, bird watchers and other nature enthusiasts. Pedestrians travel at lower speeds (3-7 miles per hour)⁷ than other types of trail users and the type of surface material is an important consideration for this group. Softer materials such as crushed rock and mulch eases strain on the lower body. The Conservancy notes that paved surfaces (concrete and asphalt) are better for pushing strollers and power-walking.

It is likely that pedestrian trails will serve both pedestrians and bicyclists. Certain considerations should be given to this assumption; AASHTO guidelines suggest that a minimum of 2 foot width shoulders be constructed to accommodate pedestrians to the side. These separate shoulders provide a path for pedestrians, and can be made with a softer material such as crushed stone.

Amenities for pedestrians along the trail include: “benches, drinking fountains, rest rooms, shelters and picnic areas.”⁸ The Conservancy recommends trail widths of at least 6 to 8 feet (excluding shoulders) and 7-foot vertical clearances from vegetation or other obstructions.

⁷ Rails-to-Trail Conservancy, *Trails for the Twenty-First Century*, 2001, p. 53.

⁸ Ibid

3.2.2 Bicycle and Shared-Use Paths

The Conservancy identifies several types of bicyclists: commuting, recreational, touring, elderly and young cyclists. For these types of trail users, the Conservancy also references AASHTO guidelines for the development of bike trails as the “national standard.” AASHTO provides guidance on sight distances, trail widths and trail clearances which are relevant to RWT/PC development. The Conservancy states that federal funding sources for bicycle facilities such as the Surface Transportation Enhancement Program (STP-E) require that AASHTO guidelines be followed.

AASHTO guidelines are discussed in more detail in Section 2 and 4 of this report. Other considerations that the Conservancy recommends for bicycle trails include adequate sight distances (of 150 feet)⁹, grades of less than 3 percent and no more than 5 percent, and signage. The signage should most importantly indicate the *shared-use* nature of the trail for both pedestrians and bicyclists. Bike racks are also an important amenity to cyclists, as well as bicycle lockers. Lockers are especially helpful to commuters, where the bicycle is completely secured and protected from the elements.

3.2.3 Mountain Bike Users

The use of a RWT/PC by mountain bikers brings different considerations in trail design. The types of mountain biker users expected for any trail should be identified before the design phase. Mountain bikers range from the casual to the more experienced. Their trail preferences range from wide, smooth, paved surfaces to narrow, dirt trails with challenging technical features. Some rider types may ride only RWT/PC trails. Others, especially more experienced and skilled mountain bikers, may use them to provide access to and/or link together challenging, off-road recreational trails.

3.2.4 Equestrian Users

The Conservancy states that multi-use equestrian trails are less common (particularly in urban areas). Equestrian trails may not be compatible with RWT/PC projects in many cases. On coming trains, particularly trains not visible to trail users, could frighten horses. Water crossings may also frighten a horse unfamiliar with the environment, and water crossings are more likely to produce unpredictable behavior in horses. It is preferable for a horse to directly cross the water rather than to use a bridge. The USDOT states that a narrow ROW is not appropriate for equestrian use, and would discourage the activity. Tunnels may present another confined situation where a horse’s behavior and flight response should be considered when evaluating the feasibility of constructing an equestrian RWT/PC.

Both the USDOT and Conservancy advise that separate facilities be constructed for equestrian users and other types of trail users. The Conservancy recommends using dirt or stabilized dirt as a trail surface, and advises against using pavement or crushed stone for an equestrian trail. Trail widths of 5 feet are sufficient, with a vertical clearance of 10 feet. Signage should indicate the multi-use nature of the trail. Other associated facilities important to equestrian users are parking and staging areas, hitching posts, restrooms, and watering locations for the horses along the trail.

⁹ Ibid, p. 55

3.2.5 Cross-Country Skiers

Shared-use paths used by pedestrians and bicyclists in the summer, fall, and spring can be used by cross-country skiers in the winter. Very little preparation is needed for a RWT/PC to be converted to a cross-country trail. The Conservancy notes that as little as six inches of snow is suitable for cross-country skiing. Maintenance activities would include keeping the trail clear of vegetation, and maintaining similar vertical clearances recommended during other seasons. Winter trail maintenance activities may also include grooming the trail for skiers.

3.2.6 Motorized Vehicles

Motorized vehicles, such as ATVs and snowmobiles, may also be accommodated on RWT/PCs, if it is decided that there are no restrictions on the use of motorized recreational equipment. The Conservancy advises that signs be posted along the trail advising of the minimum amount of snow needed to operate snowmobiles (at least six inches of snowfall). Snowmobiles may damage the trail with snow depths any less than six inches. If snowmobile use is planned, the trail should be 14 feet wide for two-way snowmobile traffic.

Vegetation should be cleared by two feet to either side of the trail, and vertical clearance of 10 feet is needed above expected snow levels. Horizontal sight distances are another important consideration. Sight distances should be at least 400 feet and a 100 foot turning radius is desirable. Bridges and tunnels present another safety issue for snowmobilers. The Conservancy recommends that snowmobiles need an 8-foot clearance on bridges, and the bridge must have a minimum carrying capacity of five tons.

Finally, the Conservancy notes that conflict can arise between pedestrians, cross-country skiers and motorized vehicles. Motorized vehicles travel at much higher rates of speed and are much noisier. Signage and user education, as with other types of multi-user trail situations, can alleviate some of the problem by providing ground rules for the various users. The Conservancy also cites other creative arrangements, where motorized vehicles and other trail users are allowed access on alternating days.

3.2.7 In-Line Skaters

In-line skaters are another group that the Conservancy identifies as a fast growing contingency of trail users in the U.S. In-line skaters travel at higher speeds than pedestrians and prefer harder, paved surfaces. The Conservancy recommends AASHTO bicycle facility guidelines be used for this type of trail user. Benches are also useful for in-line skaters to change in and out of equipment.

3.2.8 Other Users

Other types of trail users include:

- Skateboarders
- Dog sledders
- Recreational fisherman
- Pets
- Train enthusiasts

These users may have unique requirements in relation to their enjoyment and safety of the trail. For example, signage may be used to guide train enthusiasts to locations where they can photograph passing trains, or guide fisherman to fishing spots along the trail.

3.3 Considerations for Developing Trails

3.3.1 Trail Access Points

Trail access points should be well thought out depending upon the type of trail and typical user of the trail. Some studies indicate that limiting the number of access points “limits the amount of vandalism, controls user access and decreases user confusion.”¹⁰ Other issues may affect the location of trail access points, primarily the availability of land. The location of access points may also be dictated by the type of trail user the RWT/PC has been designed to serve.

Trailheads can control the intensity of use. Parking can be either expanded or restricted. Amenities can be provided which encourage/discourage casual users. Design of trailheads and access points can utilize Crime Prevention Through Environmental Design (CPTED) to encourage safe behavior and reduce the opportunities for crime to occur. Additional information on CEPTED can be obtained from the International CEPTED Association (www.cpted.net).

The Rails-to-Trails Conservancy defines two types of trail access points: Major and Minor. Minor trailheads will be less difficult to construct with simpler amenities (or associated facilities) such as shelters, picnic areas, and signage/kiosks providing guidance on the RWT/PC. Major trailheads will contain most of the associated facilities for the RWT/PC such as parking, drinking fountains, restrooms, vending machines and equipment like air pumps for bicyclists.

The National Park Service (NPS) recommends spacing major trailheads every five miles or less in rural areas where desired trail use is high; 10 miles or more where desired trail use is low; and “as needed” in urban areas. NPS recommends that minor trailheads be constructed to provide more limited access to the trail (possibly one or two parking spaces) or where the trail intersects with another trail.

A major access point should be located in such a way as to maximize the RWT/PC’s link to the community. Locating the trailhead near developed commercial/residential areas frequented by the public will provide increased safety. Developed areas also contain the built infrastructure needed for the associated facilities at a major access point. It is also preferable to minimize at-grade crossings at major trailheads, and to minimize at-grade crossings by cars accessing the trailhead.

3.3.2 Trail Connections

The Virginia Department of Conservation and Recreation (DCR) recommends that any trail planning activities in the Commonwealth be coordinated with federal, state, regional and local trail planning efforts. Additionally, DCR recommends that all local jurisdictions include a trail component in their comprehensive plans, and encourages developers to link trail

¹⁰ University of Minnesota Extension Service, *Recreational Trail Design and Construction*, Accessed at <http://www.extension.umn.edu/distribution/naturalresources/DD6371.html>

connections with other public use trails into planned developments. RWT/PCs should be evaluated within this context, as integral parts of comprehensive plans for trails in the community and state. DCR provides a statewide map of State Trails and Greenways in the *2007 Virginia Outdoors Plan* which can assist in the effort of identifying possible trail connections with new RWT/PC projects. The *Outdoors Plan* is a useful resource for general policy guidance on trails, greenways, blueways and other recreational issues that are relevant to RWT/PC planning and design.

3.3.3 Adjacent Landowner Concerns

The Conservancy recommends that the concerns of adjacent landowners be addressed *before* a RWT/PC plan or project is unveiled to the public. These landowners should be continuously engaged in the trail planning process throughout the project. Landowner concerns about safety and liability issues are similar to the railroad. Landowners may also be concerned about impacts resulting from a public use facility near their home or business.

Landowner concerns often relate to “crime, property values, and liability.” It is suggested that trail planners involve local law enforcement in the landowner/public participation process to alleviate concerns about crime. The Rails-to-Trails Conservancy studied crime trends on trails, and have compiled statistics showing the low incidence of crime on trails. If this information can be presented to landowners, it may alleviate fears of crime. The Conservancy has also studied the effects of Rails to Trails on property values and found no negative effect, and some studies have demonstrated positive effects.

4. Design Considerations

4.1 Introduction

This section provides technical design considerations for a range of RWT/PC trail features. As mentioned, this section uses the USDOT *Rails-with-Trails: Lessons Learned Study* as a primary source. Trail features discussed in this section include:

- Vertical and horizontal clearances
- Rail/trail separation techniques
- Maintenance-of-way issues
- Structures, particularly options for water crossings
- Design considerations for at-grade and grade-separated crossings
- Associated facilities/trail amenities and order of magnitude costs and needs

The information from this section utilizes graphics and cross sections which are taken directly from the USDOT *Lessons Learned Study*. **Appendix A** also summarizes this information in a table format. Please note the appropriate references under the graphics and cross sections.

These design considerations preclude equestrian trail users, which require additional horizontal and vertical clearances. Rail corridors with heavy traffic volume and/or constrained operating footprints may not be suitable for trail projects.

4.2 Clearances

4.2.1 Trail Setback Distances

The USDOT defines the term *Setback* as “the distance between the edge of the RWT/PC and the centerline of the closest active railroad.”¹¹ The setback distance is a key consideration for the RWT/PC. Trail advocates must work with the railroad to identify general setback requirements for the corridor and trail segment level. Appendix A summarizes the range of setback distances, as well as a minimal setback distance which is needed for an RWT/PC. The setback distance is dependent on a number of factors including train frequency and speed. The individual railroad may also have setback standards which will preclude general considerations provided in this report. The USDOT states that other factors should be considered when determining setbacks including:

- Train speed and frequency
- Maintenance needs
- State standards
- Separation techniques
- Historical problems
- Track curvature
- Topography

Figure 4-1, 4-2, 4-3 and 4-4 illustrate how the setback distance is determined.

¹¹ U.S. Department of Transportation, *Rails-with-Trails: Lessons Learned*, 2002

Figure 4-1: Setback Distance Defined

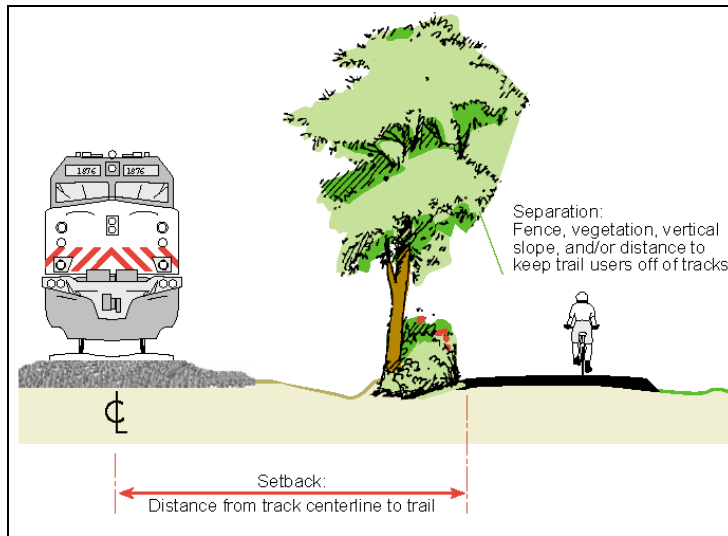

Source: U.S. Department of Transportation, *Rails-with-Trails: Lessons Learned*, 2002, p. 65

Figure 4-2: Setback Range

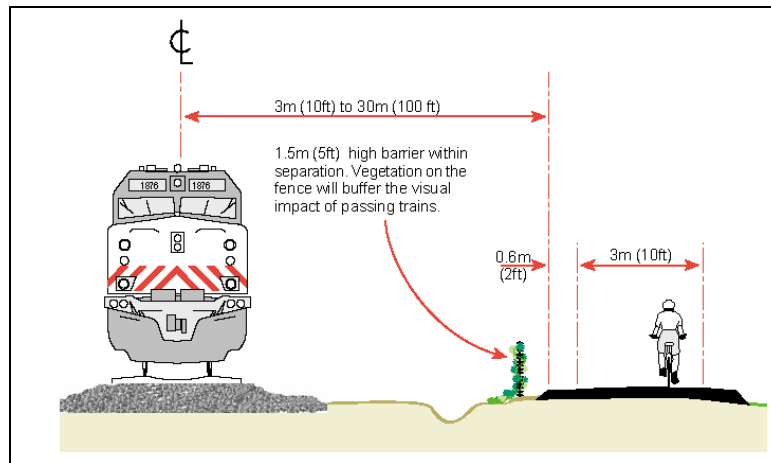

Source: U.S. Department of Transportation, *Rails-with-Trails: Lessons Learned*, 2002, p. 62

Figure 4-3: Setbacks – Constrained Section

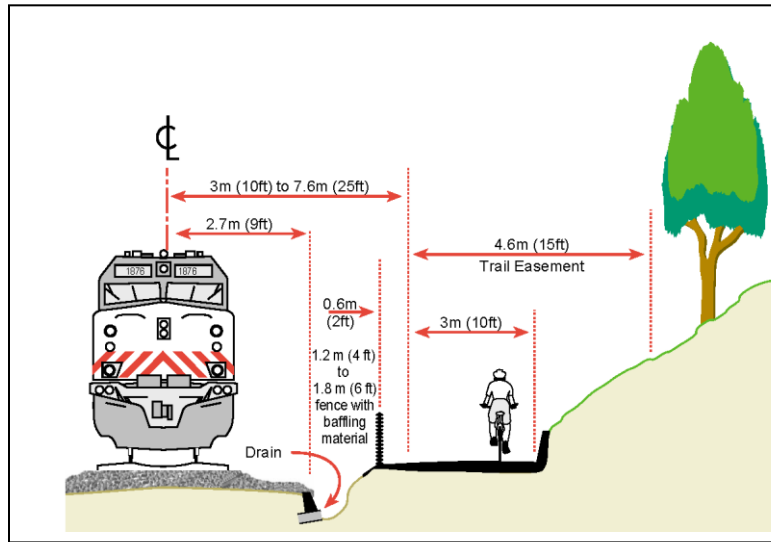

Source: U.S. Department of Transportation, *Rails-with-Trails: Lessons Learned*, 2002, p. 65

Setbacks in constrained sections of ROW present a challenge. Constrained ROW will not meet preferred setback distances met on other sections of the trail. This constraint could make the RWT/PC project itself impractical. Possible solutions in constrained ROW sections include the installation of fencing, solid barriers, or grade separations. The USDOT found that the development of RWT/PCs in these situations may only be suitable where there is low frequency and low speed train operations.

Figure 4-4: Setback – Fill Section

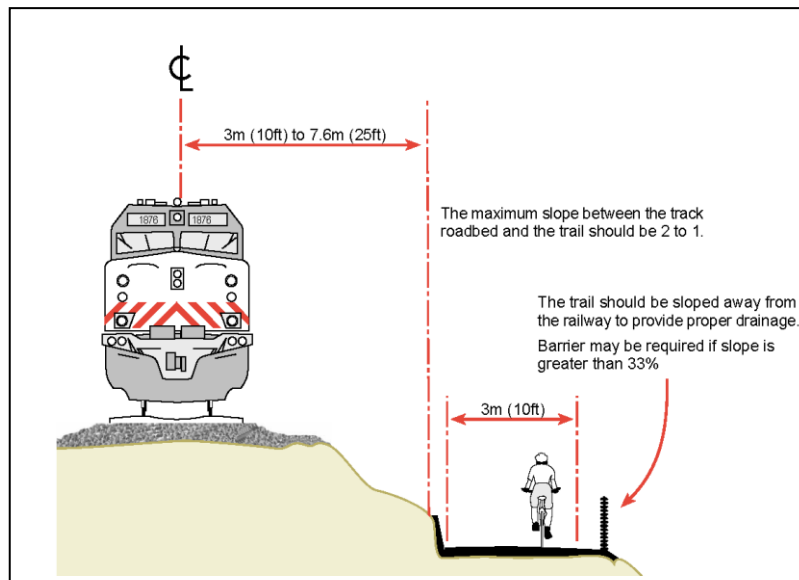

Source: U.S. Department of Transportation, *Rails-with-Trails: Lessons Learned*, 2002, p. 65

4.2.2 Vertical Clearance

Guidance on vertical clearances necessary for railroad operations are provided by AREMA's *Manual for Railway Engineering*. AREMA provides clearances for railway bridges, single and double-track railway tunnels, side and industrial tracks, highway structures over railroads and for overhead electrification. **Figure 4-5** illustrates AREMA clearance standards provided in the manual. AREMA also provides this information on a state-by-state basis; however, at the present time Virginia does not have any state regulation for vertical clearances. These guidelines are primarily relevant when grade-separated pedestrian crossings are constructed for the RWT/PC.

Figure 4-5: Clearance

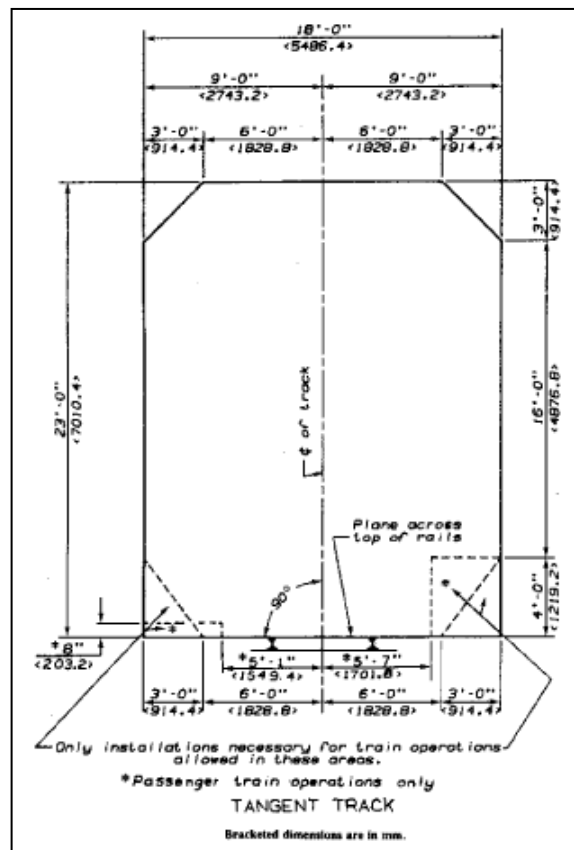

Source: American Railway Engineering and Maintenance-of-Way Association, *Manual for Railway Engineering*, 2002

4.2.3 Separations

In addition to setbacks, separation methods are used for safety and trespassing reasons. Separation techniques provide another barrier between the rail operation and trail user. The USDOT found that 70 percent of existing RWT/PCs utilize some type of separation or barrier to separate track from trail. The most common types of separations include:

- Fencing
- Vegetation/landscaping
- Vertical separations
- Berms (a 6-foot berm would require 25 feet edge-to-edge separation)
- Drainage ditches

Fencing is the most widely used separation technique for RWT/PCs, and the USDOT found that most railroad companies will *require* fencing. Fencing material can range from chain link, wire, wrought iron steel picket, wooden rail, concrete to brick. Typical heights for fences along RWT/PCs range from three to six feet. Chain link fences are cost effective, but may not be desirable aesthetically or necessary in rural areas with no history of trespassers. Wrought iron picket fences are the most effective against vandalism and trespassing but are more expensive to construct, and have a visual impact. Solid walls of concrete and brick are the most effective separation technique from a safety standpoint, but also have the most visual impact and can affect drainage of the rail bed. The USDOT recommends solid walls only be constructed in consultation with railroad engineers. Refer to p. 67 of the USDOT study for a comparison of fencing materials. In all cases physical barriers for separation must take into account the railroad's need for maintenance access along the tracks.

Vertical rail/trail grade-separations are another type of effective barrier between the railroad and the trail. The USDOT notes that vertical separation creates a safety issue where the height of the separation is greater than 10 feet, and the chance of injury from falling objects increases.

Vegetation is another effective separation technique. It may take several years for the vegetation to mature enough to become effective, however. The choice in vegetation is also important, as vegetation that grows in dense and/or thorny thickets may be more effective in deterring trail users from crossing onto the railroad bed. The USDOT recommends that vegetation not obscure sightlines for trail users who need to see oncoming trains. Also, it is important that vegetative barriers not encroach on railroad use; the railroads routinely prune vegetation to a certain distance along the ROW. This distance should be identified by the trail advocate organization in coordination with the railroad.

Berms can also serve as an effective landscaping separation. A minimum 25-foot edge-to-edge track/trail separation would be required for a 6-foot berm. Increases in berm height would require proportional increase in separation distance. **Figure 4-6** provides an example of separation technique incorporating vegetation.

Figure 4-6: Separation Technique Using Vegetation

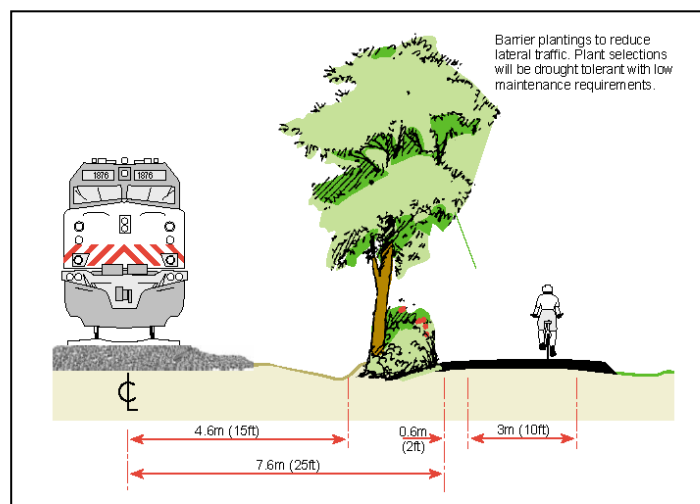

Source: U.S. Department of Transportation, *Rails-with-Trails: Lessons Learned*, 2002, p. 66

4.3 Maintenance-of-Way (MOW)

Railroads are continuously involved in a variety of maintenance, inspection, and improvement activities within a ROW. Other maintenance activities are conducted by utility companies who have installed infrastructure along the ROW. The frequency of activity — and the safety of trail and maintenance/inspection workers in proximity or involved with MOW activities — is an issue to consider early in the planning phases of the RWT/PC project. The USDOT found examples of RWT/PCs with gates installed at trailheads. Trail managers can use gates to restrict access to the trail when maintenance activities are occurring. Fencing along the ROW should also have periodic breaks (lockable gates) so that maintenance vehicles can access the tracks. Constructing the trail to standards that accommodate railroad service vehicles should also be considered.

The frequency of this work varies, dependent on the age, frequency of service, and intensity of use (gross tons over line segments) of the railroad adjacent to the RWT/PC. AREMA also states that individual railroads develop their own operational policies, thus maintenance, construction, and inspection activities will be corridor and railroad specific. It is critical that trail advocates coordinate with the railroads to identify specific maintenance activities expected to occur along the RWT/PC.

The purpose of the MOW activities is to keep the track and ROW in a condition that promotes safe and efficient railroad operations. Common MOW activities include tie renewal, ballast maintenance, rail grinding, inspection of track and facilities, rail replacement and vegetation control. In addition to normal maintenance activities there is also a need for emergency track repairs due to derailments or natural disasters that require unencumbered access to the track and ROW. Other maintenance activities outside of track maintenance include bridge and signal maintenance. Each of these activities and their potential impacts to RWT/PCs are briefly described in this section.

4.3.1 Tie Renewal

The majority of rail corridors in the Commonwealth use timber crossties as part of the track structure. These crossties are subject to wear and decay due to train loads and weather conditions. Ties must be replaced on a routine basis. Rarely are all ties replaced all at once. It is more common to replace ties as needed during routine tie renewal programs. Such programs may be as many as five to seven years apart. This work is typically conducted by 'tie gangs' who use mechanized equipment moving along the track. The equipment will remove spikes and



Photo Source: AREMA, IPRE Seminar, *Module 7: Track and ROW Maintenance* PowerPoint, Chicago, Sept. 2005

extract the worn tie from under the track, then insert a new tie which has been staged along the track. The discarded ties are then collected, bundled, loaded and removed for disposal.

This operation may require 25 feet of ROW for material handling and operations and present hazards to trail users from materials and debris along the ROW.

4.3.2 Ballast Maintenance

Stone ballast provides a stable surface for the crossties and track by distributing loads to the subgrade and providing a pathway for drainage. For a number of reasons, the ballast can require maintenance or replacement. This process is commonly referred to as surfacing, which includes removing a portion of the ballast, cleaning it by removing fine materials and placing it back under the track, and adding new material as necessary. Once the cleaning process is complete ballast regulating equipment is used to 'broom' the ballast into place. This process is typically conducted by maintenance 'gangs' using mechanized equipment. This equipment will dump new ballast and progress the operation along the track. This is a loud and dusty operation that presents safety concerns for both trail-users and railway workers.



Photo Source: AREMA, IPRE Seminar, *Module 7: Track and ROW Maintenance* PowerPoint. Chicago. Sept. 2005

4.3.3 Rail Grinding

Rail is subject to wear from train loads, especially in tight curves and on heavy-tonnage lines. It is common for railroads operating in Virginia to use the practice of rail grinding to reshape the head of the rail to promote a better interface between the rail and wheel. This process is performed by mechanized equipment which moves along the track grinding the rail head at various angles with stone wheels. This operation is very loud and throws sparks several feet in every direction. Such an environment may present hazards to trail users.

4.3.4 General Inspection of Track and Facilities

Most railroads use "Rail Defect Testing" and "Rail Geometry" cars to travel the length of the ROW. These rail vehicles automatically note locations along the rail line that require attention, such as points at which the track is "rough" and needs smoothing. Rail grinding machines are then used to smooth the track or ballast regulators are called in for corrective action.

In addition to inspection using automated machines, vehicular inspection of the ROW also occurs on a regular basis, and requires access to the track on both sides using maintenance roads. Welding, signal or work gang trucks must be able to access the areas from as close as possible, in order to quickly assess and repair problem areas detected by inspection. Large equipment, such as cranes, may be required for installation or maintenance of turnouts.

4.3.5 Rail Replacement

While steel rails have a useful life up to 40-50 years, rails do need to be replaced periodically, depending on the speed and tonnage that pass over the track. Rails located on curves and hills may wear sooner than those on tangent (straight) sections of the ROW (15 percent lifespan compared to tangent track). Rail replacement involves delivering the replacement rail to the job site via railcar and unloading at the location where the work is to be performed. Many of the tracks in the Commonwealth employ the use of continuous welded rail which is delivered and placed in sections approximately 1600-ft long. The rail is typically laid out along the track within the ROW. This can be an inherently dangerous procedure, since the long rail is unstable during positioning and may fall in any direction. Such operations may also present hazards to trail users.

4.3.6 Vegetation Control

Railroads have a need to prevent and remove vegetation along the ROW. Such vegetation can impede sight distance and block tracks after heavy winds. It is common for railroads to use both chemical spraying and heavy-duty brush cutting equipment to perform this work from either a track mounted position or along the ROW using access roads. Either operation presents hazards to trail users from turning blades, flying debris or overspray. This work is typically conducted during the spring / summer growing season, when trail use is most popular.



Source: AREMA, IPRE Seminar, *Module 7: Track and ROW Maintenance PowerPoint*, Chicago, Sept. 2005

4.3.7 Emergency Repair

Emergency repairs to the track, ties, ballast, signals or switches might be required at any time due to derailments or natural disaster. The railroads prefer, therefore, that the ROW includes access roads, where possible, on either side of the tracks to provide for a quick mobilization of the heavy equipment typically needed at the site where repairs will be made.

The equipment and materials required to handle emergencies are similar to what has been described in the preceding scenarios, albeit there is usually the added element of requiring a very quick response, which again is facilitated by having adequate access and work space.

The equipment required to handle derailed railcars and locomotives depends on the extent of the derailment. Minor derailments, where the vehicles remain upright and within the track envelope, but where the wheels come off the tracks, occur more frequently than major derailments. Freight trains are particularly susceptible to this event. In some cases, the derailed cars can be realigned with simple wheel guides, but in other cases, a crane must be brought in. Cranes are always required in the event of major derailments. This is a space-intensive operation which can involve heavy vehicles. The weight and size of these vehicles may exceed the design capabilities of lightweight trail surfaces.

The space requirements for these activities include the need for access to both sides of the ROW by dump trucks and backhoes, and to staging areas for materials.

4.3.8 Bridge Maintenance

Bridges require regular inspection, maintenance and repair, and occasionally also require emergency repair. Lack of sufficient ROW near bridges may significantly hamper bridge activities and present operational challenges.

In order to properly conduct repair and maintenance activities, materials and equipment may be pre-positioned at the repair site prior to the commencement of the work (such as a work area for crane pads, assembling structural steel, tying steel reinforcement cages, concrete pumping, and other related activities). Cranes may be needed to lift bridge spans and other materials into place, thus requiring disturbance or removal of natural vegetation. Another consideration is that often only limited space is available along the bridge itself, therefore approaches to the bridge must compensate for this constrained space.

Bridge maintenance activities may encumber trail construction or trail use. It is also conceivable that bridge construction or repair activities may require reconstruction of an adjacent trail damaged by bridge activities. Additional discussion of bridges is presented in Section 4.7.1.

4.3.9 Signal Facility Maintenance

Signal facilities are divided between wayside signals that control the movements of trains and grade-crossing signals that warn motorists and pedestrians of approaching trains. Signal facilities, including signal houses, towers and buried cables must be accessed and maintained on a regular basis. A maintenance buffer zone for these facilities should extend laterally up and down from the signal house to encompass the turnouts associated with a signal. Double track corridors require more control points and wayside signals, and therefore greater buffer areas. Trail planners should consider avoiding areas with signal controls and protecting signal facilities from tampering or vandalism. Disruptions or damage to signals may create system wide failure, operational interruptions and unsafe conditions.

4.3.10 Other Maintenance Activities

Other routine maintenance activities performed along the ROW but not described above include:

- “Couch Patrol” – which removes items abandoned on the ROW.
- Maintenance of ditches and drainage facilities, using backhoes and haulage of material removed by dump truck.
- Routine high-rail vehicle inspections required by the Federal Railroad Administration (FRA).

4.4 Security Patrols

Another important activity that takes place within the ROW are security patrols. These patrols help reduce the incidence of crime, such as vandalism and trespassing, especially in urban areas or near rail yards where trains are not moving. Access roads on either side of

the tracks must be considered for these patrols. This configuration allows for more thorough patrolling of the ROW, a quicker intervention in the event of illegal activity on the railroad, as well as providing for an efficient emergency response that might be required on either side of the ROW. Access to both sides of the track is safer for the patrol vehicles, which do not have to cross the tracks in order to respond to an incident, and does not expose the security personnel to undue risk.

4.5 Emergency Response

In addition to the security patrols, an access roadway provided on both sides of the tracks can serve as effective access for rescue vehicles and equipment to the ROW in the event of an emergency. This response could be as a result of a worker accident, a train/car collision, hazardous material spill, or a train derailment with multiple injuries. Access in these situations is critical and there is consequently a clear need to reach injured passengers and damaged rail equipment from all sides quickly, efficiently and without constraint.

4.6 Train Operations

There are other considerations related to train operations and the development of RWT/PCs, including safety considerations:

- Engineers need to see signals – generally not a problem in straight sections, but around curves they need adequate line-of-sight.
- Engineers need to be protected from distractions on any adjacent trail to minimize interference with reading signals and to remain focused on operating the train.

Freight trains can vary in length, speed and composition. On shortline railroads or trains in local service, trains may consist of a single engine with only a few cars while on Class I railroads (CSXT and NS) trains can consist of as many as four or more engines pulling 150 cars that stretch over 1.5 miles in length. Train speeds can vary as well from just a few miles per hour while in local or switching service to 60 miles per hour or more for scheduled trains on appropriate classified track. Amtrak, for instance, can run trains as fast as 79 mph where allowed.

Freight trains no longer use cabooses and as a consequence when the train locomotive passes a specific location the engineer will not have any means of monitoring what may occur alongside the train behind him. As a result, any incidents involving trail users and freight cars of a passing train would most likely not be noted by an engineer.

4.7 Structures

4.7.1 Bridges/Trestles

Bridges and trestles present one of the biggest obstacles to developing a continuous RWT/PC. However, bridges that serve both railroads as well as other users may be able to utilize additional funding sources for new construction or rehabilitation. The USDOT describes a bridge as a major constraint to the development of an RWT/PC project, and that the number of bridge crossings should be identified early in the feasibility stages. In most cases the bridges and trestles that are used by the railroads were not designed for

pedestrian and trail users. The USDOT notes that retrofit or new bridge crossing solutions for trail purposes can be devised by engineers.

Retrofit pedestrian bridges can also present a significant potential flooding problem at the water crossing. The existing rail bridge is likely to be constructed at an elevation above the 100-year flood elevation of the waterway. A retrofit pedestrian bridge may become an obstruction for the intended flow of the waterway in a flood situation. If this is determined to be the case, a new pedestrian bridge facility should be constructed away from the rail crossing at the same or higher elevation than the rail bridge. Engineering design services will be required if these trail bridge facilities are needed for the RWT/PC.

Figure 4-7 and **4-8** illustrate possible options for water crossings. These figures both illustrate retrofit pedestrian bridge structures. These structures can be fabricated offsite for easier installation. These options are likely to be the costliest part of an RWT/PC project.

Figure 4-7: Trestle Option 1

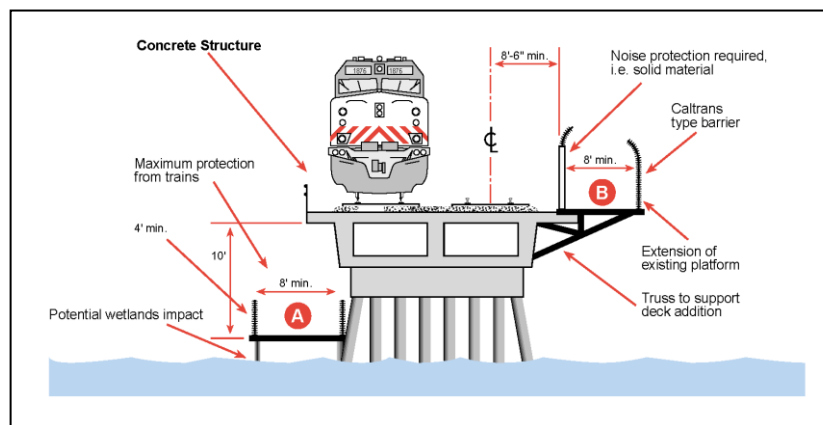

Source: U.S. Department of Transportation, *Rails-with-Trails: Lessons Learned*, 2002, pg. 86

Figure 4-8: Trestle Option 2

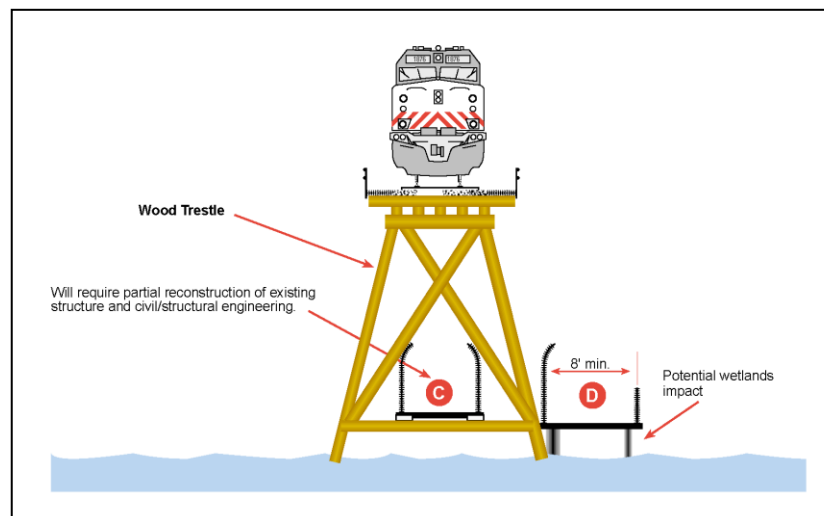

Source: U.S. Department of Transportation, *Rails-with-Trails: Lessons Learned*, 2002, pg. 86

4.7.2 Tunnels

Tunnels and culverts should also be identified in the feasibility stages of the RWT/PC project. The USDOT found that single track tunnels along a proposed RWT/PC corridor make the trail unfeasible in the line segment near the tunnel. In this case, the trail needs to deviate around the tunnel, which in most cases is impractical (supported by the presence of the tunnel in the first place). The topography and conditions at the location at one time required the tunnel. However, topography that limits rail travel may add user interest to a trail. Trails may be constructed on steeper slopes and can traverse landforms that would require a tunnel for train operation.

The USDOT notes that in cases of double track tunnels, it may be possible to use the second track, if it is no longer in use, for the RWT/PC. No examples of the use of an abandoned second track for an RWT/PC could be found however.

4.8 At-Grade Rails with Trails/Pedestrian Crossings

At-grade RWT/PC crossings should be discouraged due to railroad requirements and safety issues unless specific safety measures are incorporated on a case-by-case basis. Again, the expected number of at-grade crossings for the trail with both highway and rail should be evaluated at the feasibility stage of the RWT/PC project. As mentioned in the previous section, CSXT will not allow at-grade trail crossings. Although at-grade crossings are discouraged, the USDOT found that over half the RWT/PCs in the United States had these types of crossings. One reason at-grade crossings are still used is the additional expense of above- and below-grade crossings which could involve the construction of ramps.

4.8.1 At-Grade Highway Crossings

Figure 4-9 and 4-10 illustrates potential configurations for an at-grade crossing with an existing highway/rail crossing.

Figure 4-9: RWT At-Grade Highway Crossing Option 1 (Major Arterial)

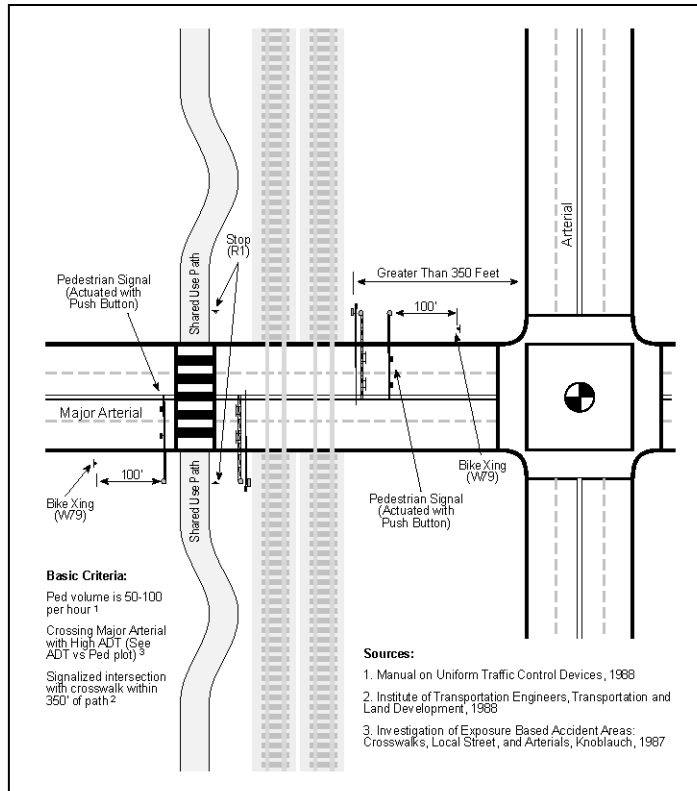

Source: U.S. Department of Transportation, *Rails-with-Trails: Lessons Learned*, 2002, pg. 82

Figure 4-10: RWT At-Grade Highway Crossing Option 2 (Major Arterial)

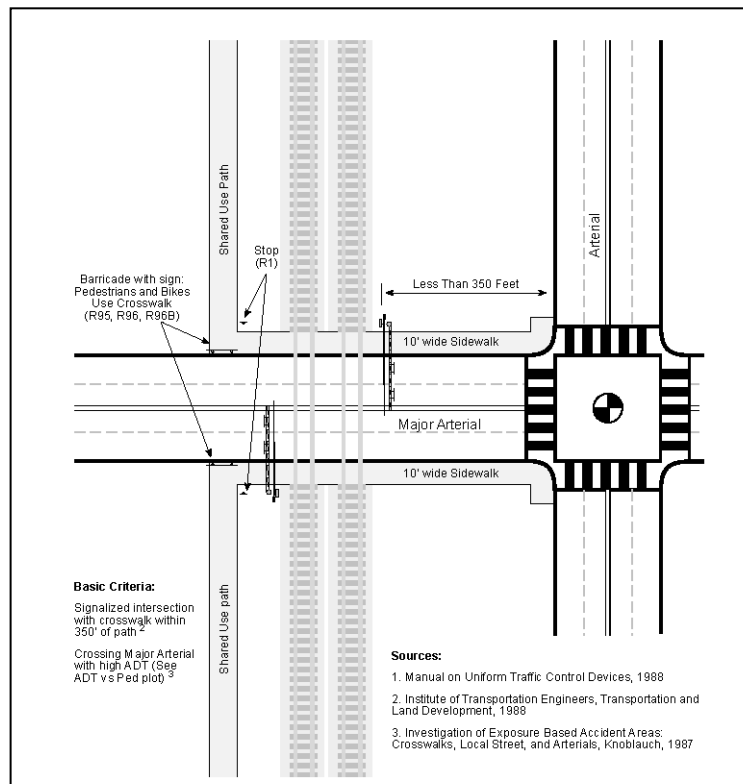

Source: U.S. Department of Transportation, *Rails-with-Trails: Lessons Learned*, 2002, pg. 82

4.8.2 At-Grade Rail/Trail Crossings

Figures 4-11 and 4-12 illustrate potential options for rail/trail at-grade crossings. Both examples illustrate crossings where warning devices are used to alert trail users.

Figure 4-11: At-Grade Rail Crossing with Passive Warning Devices

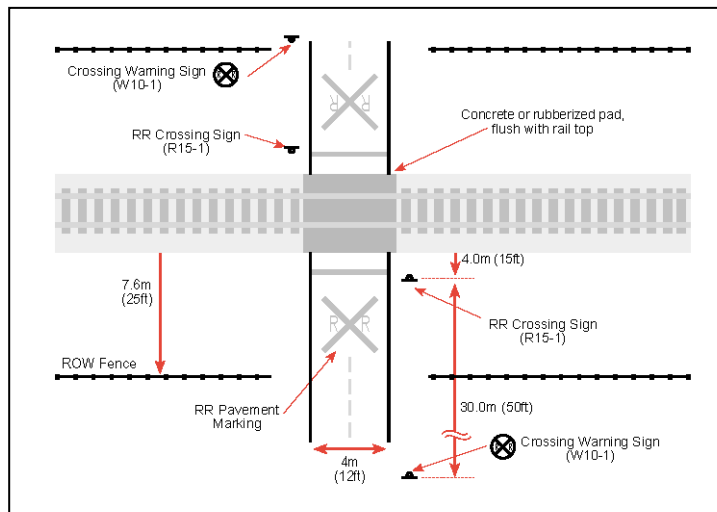

Source: U.S. Department of Transportation, *Rails-with-Trails: Lessons Learned*, 2002, pg. 74

Figure 4-12: At-Grade Rail Crossing Option with Active Warning Devices

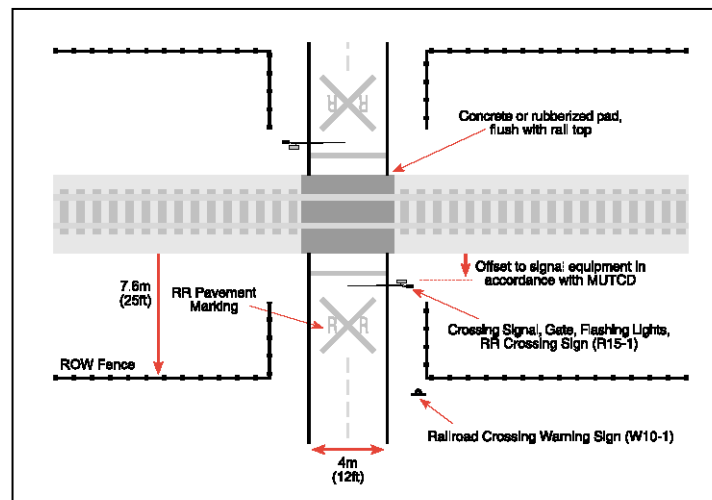

Source: U.S. Department of Transportation, *Rails-with-Trails: Lessons Learned*, 2002, pg. 74

The USDOT recommends that several factors be considered in the determination to construct an at-grade rail/trail crossing, including:

- Train frequency and speed
- Location of the crossing
- Specific site features, i.e. angle of the crossing, approach grades, sight distance
- Crossing surface
- Nighttime illumination
- Installation of warning devices

Another example of an at-grade rail crossing is shown in **Figure 4-13**. Notice the crossing is constructed at the preferred 90 degree angle. This example contains no passive or active warning devices of on coming trains for trail users.

Figure 4-13: 90° At-Grade Rail Crossing (No Warning Devices)

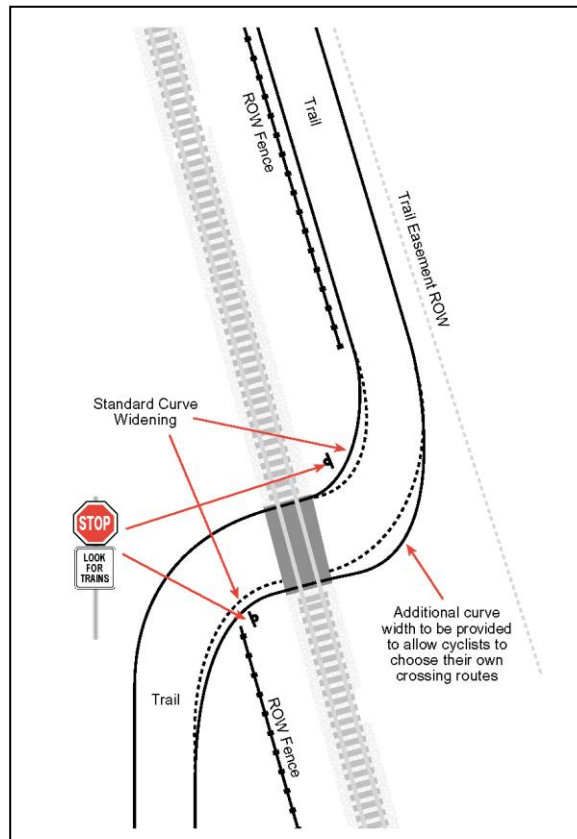

Source: U.S. Department of Transportation, *Rails-with-Trails: Lessons Learned*, 2002, pg. 73

4.9 Grade-Separated Rails with Trails/Pedestrian Crossings

Grade-separated rail/trail crossings are an effective means for increasing the safety of trail users by eliminating potential conflicts at crossings. The USDOT also provides examples of these grade-separated facilities, and uses the *AASHTO Guide for the Development of Bicycle Facilities* as a primary resource. **Figures 4-14, 4-15, 4-16 and 4-17** provide examples of grade-separated crossings.

Figure 4-14: Underpass

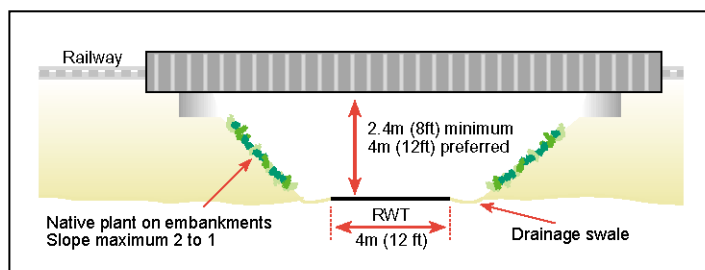

Source: U.S. Department of Transportation, *Rails-with-Trails: Lessons Learned*, 2002, pg. 79

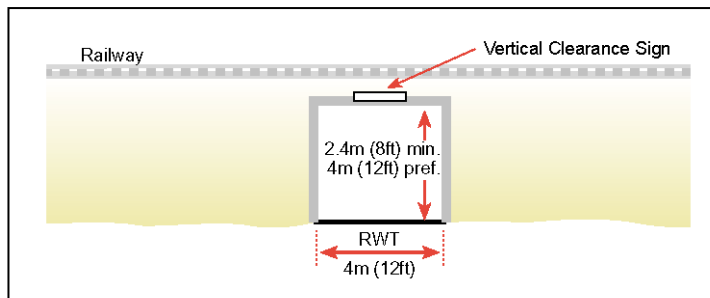
Figure 4-15: Underpass (Culvert)

Source: U.S. Department of Transportation, *Rails-with-Trails: Lessons Learned*, 2002, pg. 79

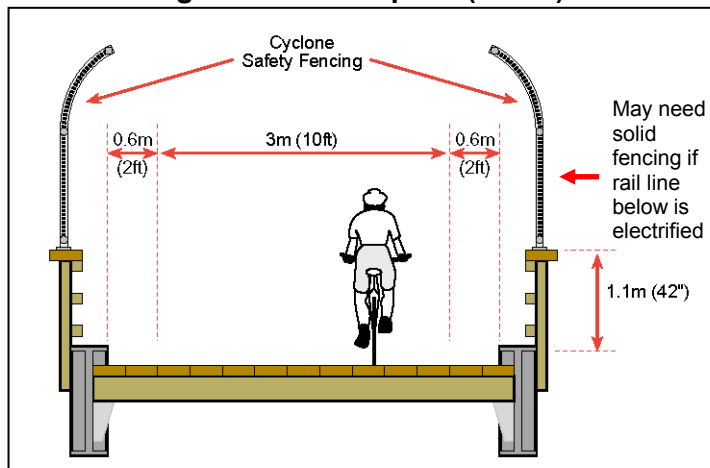
Figure 4-16: Overpass (Detail)

Source: U.S. Department of Transportation, *Rails-with-Trails: Lessons Learned*, 2002, pg. 79

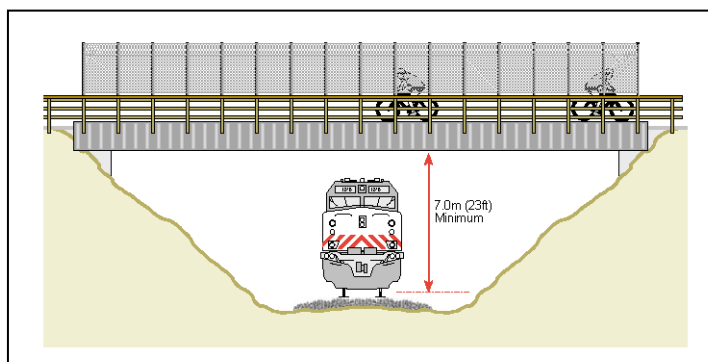
Figure 4-17: Overpass (Minimum Clearance)

Source: U.S. Department of Transportation, *Rails-with-Trails: Lessons Learned*, 2002, pg. 79

The USDOT recommends that several issues be considered when constructing these types of facilities. Grade separated structures should be constructed so that both existing and future expansion plans of the railroad can be accommodated. Poorly lit and excessively long underpasses (tunnels/culverts) can attract illegal or other undesirable activity. The USDOT also suggests that tunnels be as short as possible and well-lit at all times. These facilities require regular maintenance which should be accounted for in projecting the continuing operational costs for a RWT/PC project. Construction of these trail facilities will also disrupt normal railroad operations.

Culverts where streams pass under rail lines have the potential to also be utilized for pedestrian trails if sufficient vertical and horizontal clearances exist. The trail should be located to the side of the stream contained within the culvert and should also be located outside of the normal stream flow. In no way should the trail interfere with drainage through the culvert. Additional elements such as handrails or signage are not recommended within a stream culvert due to the potential of trapping flood debris. Depending upon the clearances and distance of the culvert beneath the rail line, it may be necessary to add overhangs to the culvert entrance/exit to prevent railroad debris from striking trail users.

In the case of an underpass beneath an open rail trestle, a roof shelter should be constructed to shield trail users from debris falling from the railroad. The structure should protect trail users walking beneath and emerging from under a trestle. In addition, the roof structure should be designed to be removable to allow the railroad to perform maintenance on the railroad structures and facilities. The trail must be designed to not interfere with drainage beneath the trestle. In all cases of trail structures, the trail sponsor would be responsible for maintenance of trail facilities including these protective structures.

4.10 Associated Facility and Trail Costs

As discussed in Section 3, identifying the type of users expected for the trail will dictate the amenities/associated facilities needed at the major and minor trailheads and along the RWT/PC. The development and construction of amenities will be dependent on funding, and could be phased in over time. Most of the amenities for the RWT/PC will be constructed at the major and minor trailheads. Estimated order-of-magnitude costs are provided in this section for typical needs of users on trail facilities. **Table 4-1** provides some general reference for the unit costs associated with trail facilities/amenities. These costs are provided by the *RSMMeans Building Construction Cost Data* reference manual, which monitors and reports materials, labor, and equipment costs for the construction industry.

Table 4-1: General Reference –Associated Facility Estimated Unit Costs

Trail Feature	Unit	Estimated Unit Cost (\$)
Parking Lot	Single Parking Space	700
Park Bench	Single Unit	630
Drinking Fountain	Single Unit	2,700
Fencing (Chain Link, Industrial, 5')	Per Mile	160,000
Lighting	Single Unit (Pole Mounted Fixture, 20')	3,500
Restroom Facility (stainless steel toilet, motion activated sink, fixtures)	Single Unit	2,100
Picnic Table	Single Unit	810
Bicycle Rack (10' Long, Permanent)	Single Unit	780
Prefabricated Pedestrian Bridge (Steel, Truss, or arch span) Not including foundation and retrofit costs	Square Foot	Approx. \$110/sq. foot

Source: RS Means, Building Construction Cost Data, 2009

Note: Unit Costs include materials, labor plus 10 percent for overhead and profit.

Table 4-2 provides general reference estimated unit costs (in 2009 dollars) for per mile and square foot for trail construction using different surface materials and widths. These costs were developed by a Northwest Indiana Regional Planning Commission for their Pedestrian and Bicycle Plan. The Planning Commission states that these costs should be used for general purposes only, and each corridor presents situations that affect construction costs. These estimates are based on the assumption of non-motorized trail use only.

Table 4-2: Reference Unit Costs for Trail Development

Trail Type	2009 Unit Cost (per Trail Mile \$)	2009 Estimated Unit Cost (per Square Foot \$)
Natural Surface (5' Width)	20,000	0.75
Wood Chip Surface (5' Width)	52,000	1.96
Granular Surface (5' Width)	153,120	5.80
Asphalt Surface (6' Width)	251,850	7.94
Concrete Surface (5' Width)	369,600	14.00
Granular Surface (10' Width)	306,240	5.80
Asphalt Surface (10' Width)	419,760	7.94
Concrete Surface (10' Width)	739,200	14.00

Note: Unit Costs include:

1. Clearing and Grubbing
2. Grading
3. Seed/Mulch
4. Other Costs: drainage, signage, and support services
5. Contingency

Source: Northwest Indiana Regional Planning Commission, *Northwest Indiana Regional Pedestrian and Bicycle Plan, Appendix B: Trail Cost Analysis*, 2005.

*Cost estimates have been adjusted using RSMMeans Historical Cost Indexes 2009

4.11 Constrained ROW Issues

Situations where the trail setback is between 10 feet and 25 feet would generally be considered constrained for a RWT/PC project. Portions of a RWT/PC Corridor that fit these criteria should be identified at the feasibility stage of the project. If significant lengths of the corridor are identified as constrained, the RWT/PC project may be impractical from a cost and safety standpoint. Narrow setbacks potentially increase the possibility of injury from falling debris, and may be more costly to construct because they may necessitate the construction of vertical separations, walls and upgraded fencing. In urban areas, RWT/PCs are likely to be constrained but will serve multiple public uses. Trains most likely will be traveling at slower speeds which may compensate for exceptions to setback requirements on a case-by-case basis.

The USDOT identifies other ROW constraints that make a RWT/PC project impractical or costly:

- Steep or “rugged” terrain
- Corridors with numerous bridges

- Locations with planned rail expansion (i.e. additional track or increased volume)
- Corridors that would require numerous at-grade or grade-separated crossings

Appendix A also summarizes some of the USDOT design considerations for constrained ROW.

Appendix A

Summary of USDOT Design Considerations

USDOT Design Considerations for Rails-with-Trails (RWT) Development

Source: US Department of Transportation, *Rails-with-Trails: Lessons Learned, Literature Review, Current Practices, Conclusions*, August 1, 2002, Section 5: Design.

	Typical ROW	Constrained ROW	Reference Page No.	Other Sources
Trail Easement Width	15 feet		p. 65	
Trail Widths	Range: 10-12 feet		p. 66	AASHTO Bike Guide, ADA guidance
Setbacks	Range: 7 - 100 feet		p. 62	
	Average: 33 feet Minimum: 6.5 feet <ul style="list-style-type: none"> • Setbacks must comply with rail operator's guidelines • Type, speed, and frequency of trains in the corridor • Separation Technique • Topography • Sight Distance • Maintenance Requirements • Historical Problems • Trespassers 	<ul style="list-style-type: none"> • Narrow cut and fill sections • Very steep or other rugged terrain • Numerous bridges and tunnels 	p. 62 p. 63 p. 63 p. 64	Volpe, 1999
Separation Techniques			p. 68	
Fencing	<ul style="list-style-type: none"> • 3-6 foot typical height (6 foot rail spec) • Expensive to maintain • Liability risk if poorly maintained • May distract from aesthetic quality of trail • Particularly effective in urban areas 			
Vegetation	<ul style="list-style-type: none"> • High density thickets of tall grasses, trees and shrubs 			
Vertical Separations	<ul style="list-style-type: none"> • Less than 10 feet. Potential solution for cut and fill locations 			
Drainage Ditches	<ul style="list-style-type: none"> • Acts as deterrent, deeper and wider ditches are more difficult to cross 			

USDOT Design Considerations for Rails-with-Trails (RWT) Development

Source: US Department of Transportation, *Rails-with-Trails: Lessons Learned, Literature Review, Current Practices, Conclusions*, August 1, 2002, Section 5: Design.

	Typical ROW	Constrained ROW	Reference Page No.	Other Sources
At-Grade Railroad Track Crossings	<ul style="list-style-type: none"> • At-grade crossings should be avoided wherever possible 		P. 69-78	FHWA, <i>Railroad-Highway Grade Crossing Handbook</i> , 1986
	<ul style="list-style-type: none"> • Use of existing highway-rail crossings may be an option • Train Frequency and Speed • Location of Crossing and channelization of users • Sight Distances • Advance notice of crossing • Traffic control device comprehension by trail users • Ability for trail users to see approaching train • Specific geometrics of site - approach grades and angles • Crossing Surface • Nighttime illumination • Types of warning devices (passive and/or active) • Automatic gates • Signage • Warning Alarms 		<p>p. 71</p> <p>p. 71</p> <p>p. 71</p> <p>p. 71</p> <p>p. 71</p> <p>p. 72</p> <p>p. 74</p> <p>p. 74</p> <p>p. 70</p> <p>p. 77-78</p> <p>p. 75</p> <p>p. 74</p>	<p><i>AASHTO Bike Guide, ADA guidance</i></p> <p><i>AASHTO Bike Guide, ADA guidance</i></p> <p><i>Illumination Engineering Society, American National Standard Practice for Roadway Lighting ANSI IESNA RP-8</i></p> <p><i>Manual of Uniform Traffic Control Devices</i></p> <p><i>Manual of Uniform Traffic Control Devices</i></p>
Grade-Separated Railroad Track Crossings	<ul style="list-style-type: none"> • Below-grade and above-grade crossings are preferable, although expensive 		p. 79	<i>AASHTO Bike Guide</i>
Trail Overpasses	<p>Minimum: 23 foot vertical clearance (for railroads)</p> <p>Trail Widths: 14-16 feet</p>		<p>p. 79</p> <p>p. 79</p>	<p><i>AASHTO Bike Guide</i></p> <p><i>AASHTO Bike Guide</i></p>
Trail Underpasses	<p>Minimum: 8 foot vertical clearance</p> <p>Preferred: 12 foot vertical clearance</p> <p>Trail Widths: 14-16 feet</p> <ul style="list-style-type: none"> • Existing and Future Railroad Operations • Safety and Security of facility • Maintenance 		<p>p. 79</p> <p>p. 79</p> <p>p. 79</p> <p>p. 79</p> <p>p. 79</p>	<p><i>AASHTO Bike Guide</i></p> <p><i>AASHTO Bike Guide</i></p> <p><i>AASHTO Bike Guide</i></p>

USDOT Design Considerations for Rails-with-Trails (RWT) Development

Source: US Department of Transportation, *Rails-with-Trails: Lessons Learned, Literature Review, Current Practices, Conclusions*, August 1, 2002, Section 5: Design.

	Typical ROW	Constrained ROW	Reference Page No.	Other Sources
Trail-Roadway Crossings			p. 81-84	AASHTO Bike Guide, Manual of Uniform Traffic Control Devices
At-Grade Crossings	<ul style="list-style-type: none"> ▪ Routing path to nearest signalized intersection is more desirable ▪ Combination Rail/Highway/Trail grade-crossings should be avoided ▪ Motor vehicle traffic need additional warnings for rail and trail traffic ▪ Right-of-Way Assignments ▪ Traffic Control Devices (including automatic gates) ▪ Sight Distances ▪ Pavement Markings ▪ Turning Movements ▪ Traffic Volume ▪ Operating Speeds ▪ Number of Lanes 		<p>p. 81-82, Figure 5.35</p> <p>p. 81-82, Figure 5.38</p>	
Grade-Separated Crossings	<ul style="list-style-type: none"> ▪ Applicable in situations where highway average speeds are above 45 mph or traffic volume is greater than 20,000 vehicles per day 		p. 84	
Utilities	<ul style="list-style-type: none"> ▪ Location and operation of surface and sub-surface utilities on ROW should be identified 		p. 84	
	<ul style="list-style-type: none"> ▪ Utility maintenance requirements should be identified ▪ Utility easement arrangements should be identified ▪ Associated Facilities on ROW 		<p>p. 84</p> <p>p. 84</p> <p>p. 84</p>	
Accommodating Future Tracks and Sidings	<ul style="list-style-type: none"> ▪ Future rail expansion must be considered 	<ul style="list-style-type: none"> ▪ Planned rail improvements would eliminate RWT 	p. 85	
	<ul style="list-style-type: none"> ▪ RWT should be located opposite of existing and planned sidings/tracks ▪ Easement arrangements may include stipulations to eliminate RWT for expansion 		<p>p. 85</p> <p>p. 85</p>	

USDOT Design Considerations for Rails-with-Trails (RWT) Development

Source: US Department of Transportation, *Rails-with-Trails: Lessons Learned, Literature Review, Current Practices, Conclusions*, August 1, 2002, Section 5: Design.

	Typical ROW	Constrained ROW	Reference Page No.	Other Sources
Trestles and Bridges	<ul style="list-style-type: none"> • Most significant constraint in RWT development 		p. 86	
	<ul style="list-style-type: none"> • Bridges and trestles generally not designed for pedestrians and bicyclists • Most costly portion of RWT's development • Two possible solutions-use existing structure or build new structure • New pedestrian bridge structures may have negative environmental impacts 		<p>p. 86</p> <p>p. 86</p> <p>p. 86</p> <p>p. 86</p>	
Tunnels	<ul style="list-style-type: none"> • Dual Tunnel/RWT use should be avoided 		p.87	
	<ul style="list-style-type: none"> • Single track tunnels usually make RWT's unfeasible (in tunnel portion of trail) • If necessary, RWT's should be diverted over and around tunnel structure 		<p>p. 87</p> <p>p. 88</p>	
Environmental Constraints	<ul style="list-style-type: none"> • Study recommends Environmental Assessment (per NEPA) as part of an RWT Feasibility Study 		p. 88	
Support Facilities and Amenities			p.89, Figure 5.42	
Trailheads and Parking Areas	<ul style="list-style-type: none"> • Should be located on same side as RWT to avoid pedestrian track crossings • RWT Feasibility Study should analyze trail access to neighboring communities • Projects of annual and peak-day usage are recommended, and modal split • Trailhead may include restrooms, entrance signs and maps, kiosks, and drinking fountains 		<p>p.89</p> <p>p.89</p> <p>p. 89</p> <p>p. 89</p>	
Landscaping	<ul style="list-style-type: none"> • Landscaping offers visual and aesthetic benefits, erosion control and screening from sun and wind • Landscaping should be considered at trailheads and other gateways to RWT • Native, drought resistant species should be utilized • Landscaping should not interfere with railroad maintenance or sightlines for motorists and rail employees 		<p>p. 89</p> <p>p. 89</p> <p>p. 89</p> <p>p. 89</p>	
Drainage	<ul style="list-style-type: none"> • RWT Feasibility Study must include analysis and costs for maintaining or enhancing rail bed drainage 		p. 90	
Lighting	<ul style="list-style-type: none"> • The installation of lighting dependant on installation, operational, and maintenance costs • Use as a commuter facility make RWT better candidate for lighting • At-grade and undercrossing should have lighting for safety and visibility reasons • Lighting impacts to neighborhoods and rail operations should be evaluated • Motion activated lighting may be considered to minimize lighting impacts 		<p>p. 90</p> <p>p. 90</p> <p>p. 90</p> <p>p. 90</p> <p>p. 90</p>	

USDOT Design Considerations for Rails-with-Trails (RWT) Development

Source: US Department of Transportation, *Rails-with-Trails: Lessons Learned, Literature Review, Current Practices, Conclusions*, August 1, 2002, Section 5: Design.

	Typical ROW	Constrained ROW	Reference Page No.	Other Sources
Signing and Markings	<ul style="list-style-type: none"> ▪ Signage should follow MUTCD standards ▪ Feasibility Study should present design and cost specifications for signage 		p. 90	<i>Manual of Uniform Traffic Control Devices (MUTCD)</i>
Equestrian Considerations	<ul style="list-style-type: none"> ▪ Equestrian use should be considered carefully because of horse's instinctive flight behavior ▪ Wider trails are necessary - narrow ROW make equestrian use unattractive ▪ Water crossings may also have negative consequences to animal behavior 	<ul style="list-style-type: none"> ▪ Equestrian use not recommended 	<p>p. 91</p> <p>p. 91</p> <p>p. 91</p>	
Considerations for Steam Locomotives	<ul style="list-style-type: none"> ▪ Steam locomotives require additional setback distance for safe operation ▪ Additional setbacks and other safety measure should be addressed in Feasibility Study 	<ul style="list-style-type: none"> ▪ Not recommended 	<p>p. 91</p> <p>p. 91</p>	